

300 - 400

UNIDRILL

PLEASE READ CAREFULLY BEFORE USING THE MACHINE

August 2001

System
Moore

33 Kirk Road, Ballymoney, Co. Antrim,
Northern Ireland BT53 6PP.
Tel: (028) 2766 4444
Fax: (028) 2766 5696

Dear Customer



Thank you for trusting our equipment and choosing the UNIDRILL.

To Ensure correct operation, and make full use of your seed drill's capabilities, we recommend that you read this operators manual carefully.

Please do not hesitate to make suggestions or comments based on your experience; they will always be of use to us, and will help us improve our products.

Please return the duly completed guarantee form to us.

We wish you success with your seed drill.

Yours sincerely

Sam Moore
Managing Director

Guarantee Form



Moore Uni Drill Limited
33 Kirk Road, Ballymoney,
Co. Antrim, N Ireland, BT53 6PP
TEL: (++44) 028276 64444
FAX: (++44) 028276 65696
Email: info@moore-unidrill.com
Website: www.moore-unidrill.com

Machine Width: _____

Serial Number: _____

Customer Name: _____

Tel: _____

Address: _____

Mobile No: _____

Email: _____

Post Code: _____

I HAVE RECEIVED THE ABOVE MACHINE IN AN ACCEPTABLE
CONDITION AND TO THE CORRECT SPECIFICATION.

I HAVE RECEIVED AND READ THE OWNERS MANUAL FOR SAFE
AND CORRECT OPERATION OF MACHINE.

I WISH TO REGISTER MY MACHINE FOR WARRANTY.

SIGNED:- _____ *CUSTOMER* *DATE:-* _____

1. To be completed, detached and returned to Moore Uni Drill within 14 days of customer receipt / purchase.
2. It is essential that all details be completed.
3. Failure to complete and return this form will prevent claim settlement.

Declaration of Conformity



DECLARATION OF CONFORMITY

Moore Uni Drill Limited,

Of 33 Kirk Road, Ballymoney, Co. Antrim, N. Ireland. BT53 6PP

hereby declare that

Model
Serial No
Date

conforms with the following Directives and Regulations, and has been certified accordingly.

The Essential Health and Safety Regulations Directive. 98 - 37 - EC
The Proposed Seed Drills Safety Document 2000
(00 / 714171 DC)

Certified on behalf of Moore Uni Drill Limited

James A O' Kane

Design Engineer
Date: 17 - 05 - 2001

Safety Regulations



Risk of accident



Risk of damage to the machine



Operating tip

● These symbols are used in these instructions every time recommendations are provided concerning your safety, the safety of others or the correct operation of the machine.

● These recommendations must be given to all users of the machine.

GENERAL SAFETY REGULATIONS

Every time the tractor/machine assembly is to be started up and used, you should ensure beforehand that it complies with current legislation on safety at work and Road Traffic regulations.

GENERAL

- 1 - In addition to the instructions contained in this manual, legislation relating to safety instructions and accident prevention should be complied with.
- 2 - Warnings affixed to the machine give indications regarding safety measures to be observed and help to avoid accidents.
- 3 - When travelling on public roads, abide by the provisions of the Highway Code.
- 4 - Before starting work, it is essential that the user familiarizes himself with the control and operating elements of the machine and their respective functions. When the machine is running, it may be too late.
- 5 - The user should avoid wearing loose clothing which may be caught up in the moving parts.
- 6 - We recommend using a tractor with a safety cab or roll bar conforming to standards in force.
- 7 - Before starting up the machine and beginning work, check the immediate surroundings, particularly for children. Make sure that visibility is adequate. Clear any persons or animals out of the danger zone.
- 8 - It is strictly forbidden to transport any persons or animals on board the machine whether it is in operation or not.
- 9 - The machine should only be coupled up to the tractor at the specially provided towing points and in accordance with applicable safety standards.
- 10 - Extreme care must be taken when coupling or uncoupling the machine from the tractor.
- 11 - Before hitching up the machine, ensure that the front axle of the tractor is sufficiently weighted. Ballast weights should be fitted to the special supports in accordance with the instructions of the tractor manufacturer.
- 12 - Do not exceed the maximum axle weight or the gross vehicle weight rating.
- 13 - Do not exceed the maximum authorized dimensions for using public roads.
- 14 - Before entering a public road, ensure that the protective and signalling devices (lights, reflectors, etc.) required by law are fitted and working properly.
- 15 - All remote controls (cords, cables, rods, hoses, etc.) must be positioned so that they cannot accidentally set off any manoeuvre which may cause an accident or damage.

16 - Before entering a public road, place the machine in the transport position, in accordance with the manufacturer's instructions.

17 - Never leave the driver's position whilst the tractor is running.

18 - The speed and the method of operation must always be adapted to the land, roads and paths. Avoid sudden changes of direction under all circumstances.

19 - Precision of the steering, tractor adhesion, road holding and effectiveness of the braking mechanism are influenced by factors such as the weight and nature of the machine being towed, the front axle stage and the state of the land or path. It is essential, therefore, that the appropriate care is taken for each situation.

20 - Take extra care when cornering, taking account of the overhang, length, height and weight of the machine or trailer being towed.

21 - Before using the machine, ensure that all protective devices are fitted and in good condition. Damaged protectors should be replaced immediately.

22 - Before using the machine, check that nuts and screws are tight, particularly those for attaching tools (discs, flickers, deflectors, etc.). Tighten if necessary.

23 - Do not stand in the operating area of the machine.

24 - Caution! Be aware of any crushing and shearing zones on remote-controlled and particularly hydraulically-controlled parts.

25 - Before climbing down from the tractor, or before any operation on the machine, turn off the engine, remove the key from the ignition and wait until all moving parts have come to a standstill.

26 - Do not stand between the tractor and the machine until the handbrake has been applied and/or the wheels have been wedged.

27 - Before any operation on the machine, ensure that it cannot be started up accidentally.

28 - Do not use the lifting ring to lift the machine when it is loaded.

PROPER USE OF THE MACHINE

The Seed drill must only be used for tasks for which it has been designed.

The manufacturer will not be liable for any damage caused by using the machine for applications other than those specified by the manufacturer. Using the machine for purposes other than those originally intended will be done so entirely at the user's risk.

Proper use of the machine also implies:

- complying with instructions on use, care and

maintenance provided by the manufacturer; - using only original or manufacturer recommended spare parts, equipment and accessories.

The Seed drill must only be operated, maintained and repaired by competent persons, familiar with the specifications and methods of operation of the machine. These persons must also be informed of the dangers to which they may be exposed.

The user must strictly abide by current legislation regarding:

- accident prevention;
- safety at work (Health and Safety Regulations);
- transport on public roads (Road Traffic Regulations).

Strict compliance with warnings affixed to the machine is obligatory.

The owner of the equipment shall become liable for any damage resulting from alterations made to the machine by the user or any other person, without the prior written consent of the manufacturer.

The noise created by the machine does not exceed 70 decibels.

HITCHING

1 - When hitching or unhitching the machine from the tractor, place the control lever of the hydraulic lift in such a position that the lifting mechanism cannot be activated accidentally.

2 - When hitching the machine to the three-point lifting mechanism of the tractor, ensure that the diameters of the pins or gudgeons correspond to the diameter of the tractor ball joints.

3 - Caution! In the three-point lifting zone, there may be a danger of crushing and shearing.

4 - Do not stand between the tractor and the machine whilst operating the external lift control lever.

5 - When in transport, lifting mechanism stabilizer bars must be fitted to the machine to avoid floating and side movement.

6 - When transporting the machine in the raised position, lock the lift control lever.

DRIVE EQUIPMENT

(Power take-off and universal drive shafts)

1 - Only use universal drive shafts supplied with the machine or recommended by the manufacturer.

2 - Power take-off and universal drive shaft guards must always be fitted and in good condition.

- 3 - Ensure that the tubes of the universal drive shafts are properly guarded, both in the working position and in the transport position.
- 4 - Before connecting or disconnecting a universal drive shaft, disengage the power take-off, turn off the engine and re-move the key from the ignition.
- 5 - If the primary universal drive shaft is fitted with a torque limiter or a free wheel, these must be mounted on the machine power take-off.
- 6 - Always ensure that universal drive shafts are fitted and locked correctly.
- 7 - Always ensure that universal drive shaft guards are immobilized in rotation using the specially provided chains.
- 8 - Before engaging power take-off, ensure that the speed selected and the direction of rotation of the power take-off comply with the manufacturer's instructions.
- 9 - Before engaging power take-off, ensure that no persons or animals are close to the machine.
- 10 - Disengage power take-off when the universal drive shaft angle limits laid down by the manufacturer are in danger of being exceeded.
- 11 - Caution! When power take-off has been disengaged, moving parts may continue to rotate for a few moments. Do not approach until they have reached a complete standstill.
- 12 - On removal from the machine, rest the universal drive shafts on the specially provided supports.
- 13 - After disconnecting the universal drive shafts from the power take-off, the protective cap should be fitted to the power take-off.
- 14 - Damaged power take-off and universal drive shaft guards must be replaced immediately.

HYDRAULIC CIRCUIT

- 1 - Caution! The hydraulic circuit is pressurized.
 - 2 - When fitting hydraulic motors or cylinders, ensure that the circuits are connected correctly in accordance with the manufacturer's guidelines.
- The Pressure line of the hydraulic circuit is marked with a red probe cover. The Return line of the hydraulic circuit is marked with a blue probe cover.

- 3 - Before fitting a hose to the tractor's hydraulic circuit, ensure that the tractor-side and machine-side circuits are not pressurized.
- 4 - The user of the machine is strongly recommended to identify the hydraulic couplings between the tractor and the machine in order to avoid wrong connection. Caution! There is a danger of reversing the functions (for example: raise/lower).
- 5 - Check hydraulic hoses once a year:
 - . Damage to the outer surface
 - . Porosity of the outer surface
 - . Deformation with and without pressure
 - . State of the fittings and seals
 The maximum working life for hoses is 6 years. When replacing them, ensure that only hoses with the specifications and grade recommended by the machine manufacturer are used.
- 6 - When a leak is found, all necessary precautions should be taken to avoid accidents.
- 7 - Pressurized liquid, particularly hydraulic circuit oil, may cause serious injury if it comes into contact with the skin. In the case of injury, consult a doctor immediately. There is a risk of infection.
- 8 - Before any operation on the hydraulic circuit, lower the machine, release the pressure from the circuit, turn off the engine and remove the key from the ignition.

- 4 - When replacing a working part (fertilizer spreader blade or seed drill coulter), wear protective gloves and only use appropriate tools.
- 5 - To protect the environment, it is forbidden to throw away oil, grease or filters of any kind. Give them to specialist recycling firms.
- 6 - Before operating on the electric circuit, disconnect the power source.
- 7 - Protective devices likely to be exposed to wear and tear should be checked regularly. Replace them immediately if they are damaged.
- 8 - Spare parts should comply with the standards and specifications laid down by the manufacturer. Only use Moore Spare Parts.
- 9 - Before commencing any electric welding work on the tractor or the towed machine, disconnect the alternator and battery cables.
- 10 - Repairs affecting parts under stress or pressure (springs, pressure accumulators, etc.) should be carried out by suitably qualified engineers with special tools.

MAINTENANCE

- 1 - Before commencing any maintenance, servicing or repair work, or before attempting to locate the source of a breakdown or fault, it is essential that the power take-off is disengaged, the engine turned off and the key removed from the ignition.
- 2 - Check regularly that nuts and screws are not loose. Tighten if necessary.
- 3 - Before carrying out maintenance work on a raised machine, prop it up using appropriate means of support.

DANGER

- 1 Side marker operating zone
- 2 Moving parts
- 3 Do not travel on the platform
- 4 Rotating agitator shaft
- 5 Crushing risk when hitching

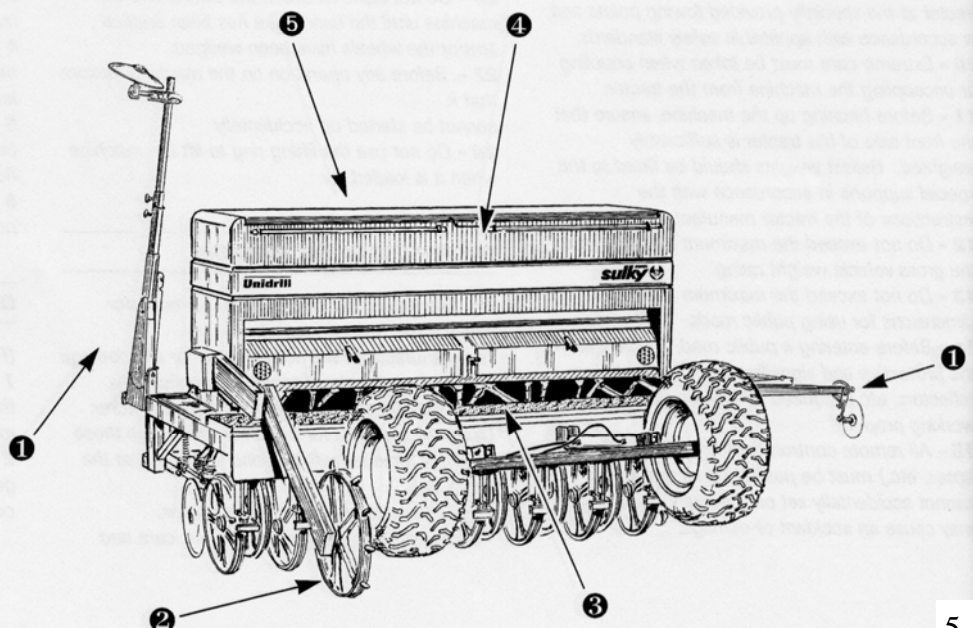

Warning Symbols 1



Carefully read operator's manual before handling the machine. Observe instructions and safety rules when operating.



Stay a safe distance from the machine.



Insert safety lock before getting into hazardous area.



Never reach into rotating auger.



Never reach into the crushing danger area as long as parts may move.



Do not ride on platform or ladder.

Warning Symbols 2

Tighten implement wheel studs after the first 4 working hours and then daily thereafter

Ensure wheel nuts are tight



DANGER
TRANSPORT PINS MUST BE USED BEFORE WORKING ON THE MACHINE WHILST IN THE RAISED POSITION

Ensure transport pins are used when working under raised machine



Do not work under raised marker



OPERATOR INFORMATION
IT IS THE RESPONSIBILITY OF THE DRILL OPERATOR TO CHECK THE TRAMLINE IS FUNCTIONING IN THE CORRECT SEQUENCE, AFTER EVERY HOPPER REFILL, AND ALSO ENSURE THE TRAMLINE SYSTEM FUNCTIONS IN THE CORRECT SEQUENCE WITH THE DRILLING TRACTORS 12V POWER SOURCE.

Ensure the tramline system is functioning correctly after each fill

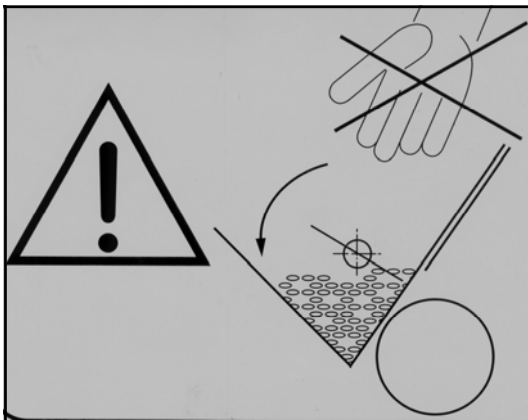

Never reach into rotating auger



Forward speed should not exceed 25 KPH

Safety / Instruction Decals

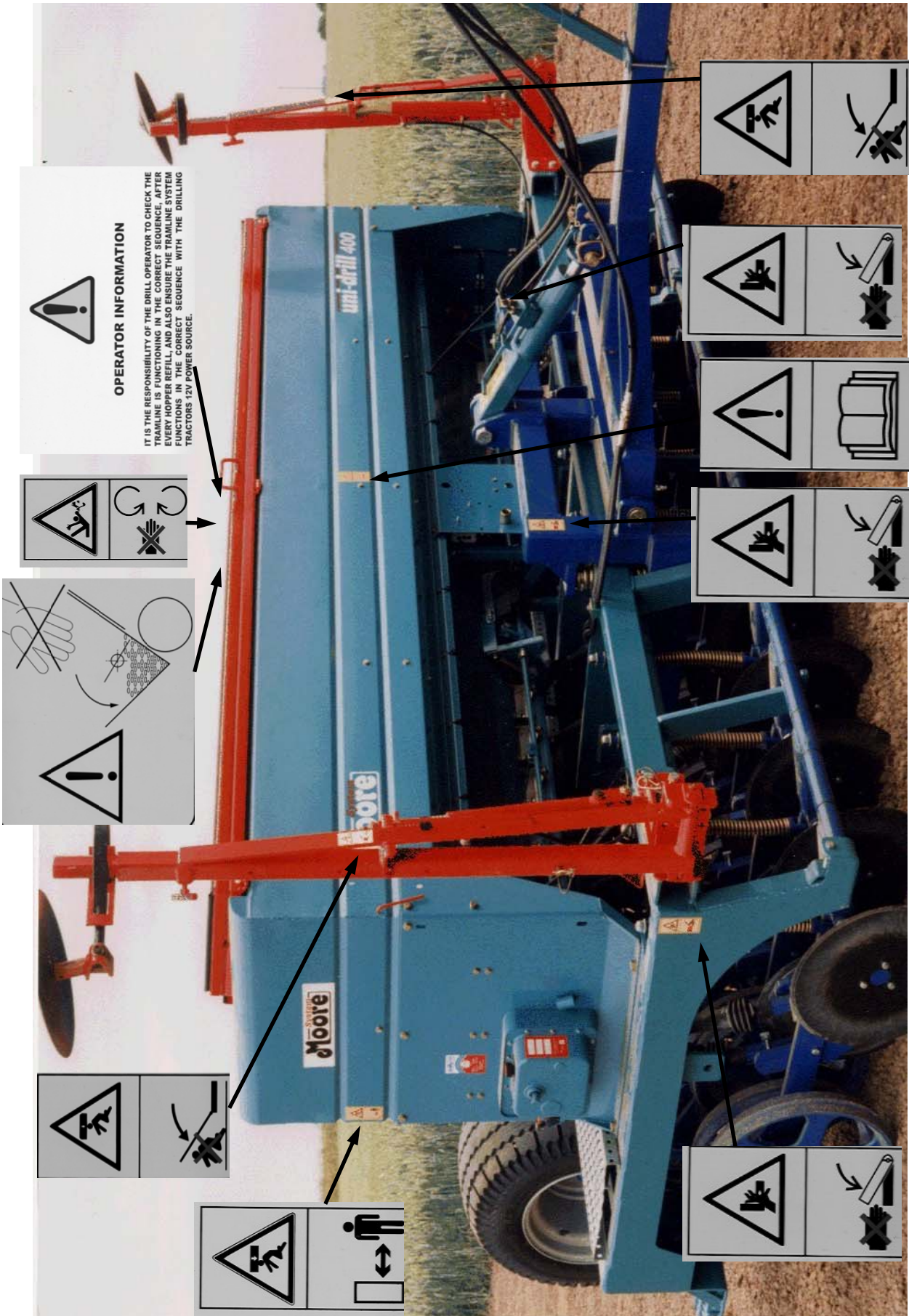

Safety / Instruction Decals

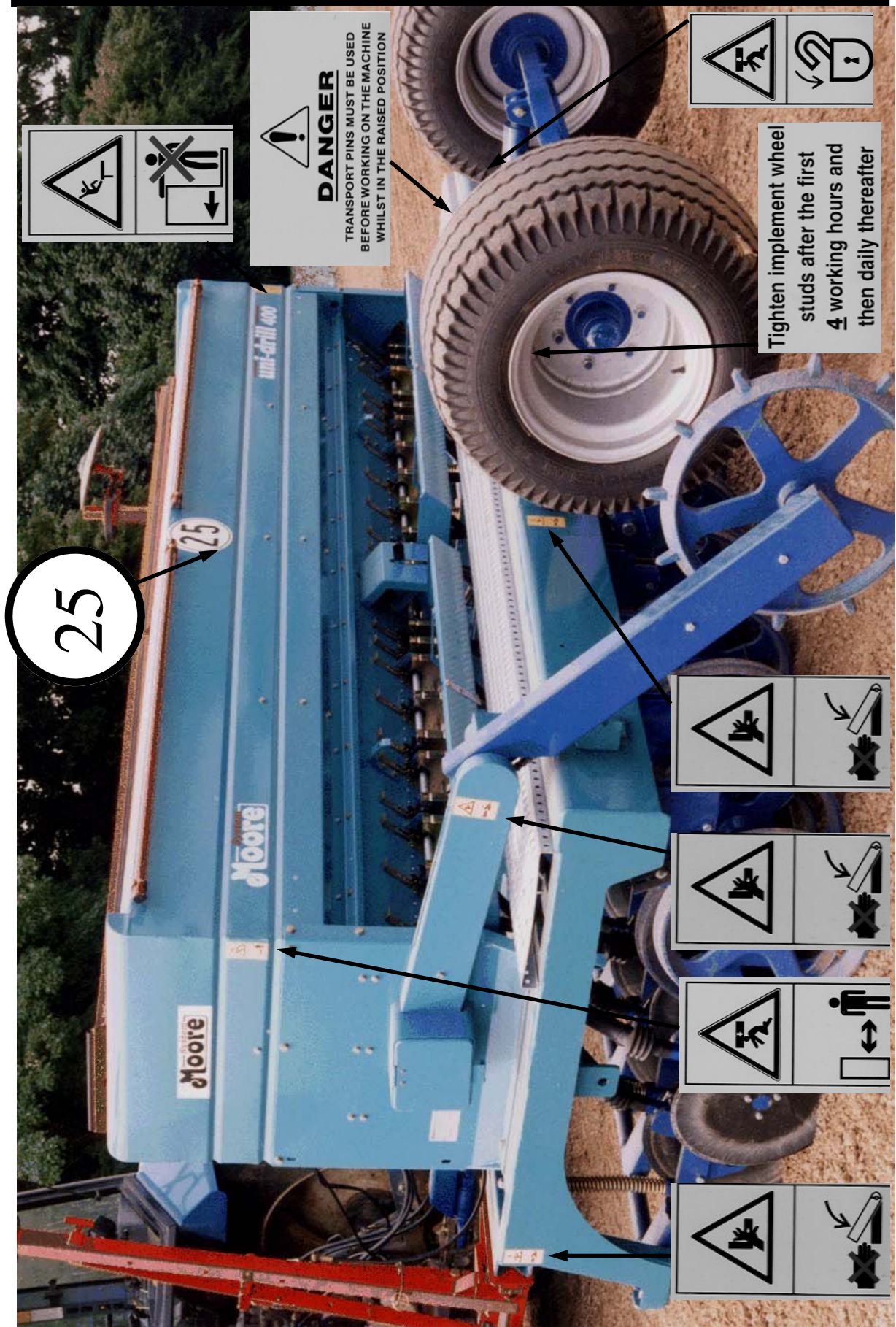

Technical Specifications

Identification

When accepting ownership of your machine note the following information:

Serial Number: _____

Type of machine: _____

Accessories: _____

Technical Specifications

MOORE UNIDRILL	240M Grassland	240 Grassland
Width (m)	2.4	2.4
Number of rows	18	18
Row spacing (cm)	13.3	13.3
Width in transport (m)	2.4	2.4
Hopper capacity (l)	700	700
Weight (Kg)	2150	2400
Horse Power Required (HP)	90	90

MOORE UNIDRILL	300 Grassland	300M Arable	300 Arable
Width (m)	3	3	3
Number of rows	22	18	18
Row spacing (cm)	13.3	16.6	16.6
Width in transport (m)	3	3	3
Hopper capacity (l)	700	1150	1150
Weight (Kg)	2750	2500	2750
Horse Power Required (HP)	100	100	100

MOORE UNIDRILL	400 Arable
Width (m)	4
Number of rows	24
Row spacing (cm)	16.6
Width in transport (m)	4
Hopper capacity (l)	1600
Weight (Kg)	3150
Horse Power Required (HP)	120

Contents

Acknowledgments	1
Guarantee Form	2
Declaration of conformity	3
Safety Regulations	4 - 5
Warning Symbols 1	6
Warning Symbols 2	7
Safety / Instruction Decals	8 - 9
Technical Specifications	10
Contents	11 - 12
SECTION 1 STARTING UP	
- Preparation and calibration, running in, seedbed preparation	13
- Hitching - Trailed drill	14
- Hitching - Mounted drill	15
- Transport, Hydraulic connections	16
SECTION 2 SETTINGS	
- Distribution shutter, Base flap	17
- Selecting the peg wheel, variator	18
- Preparing calibration test	19
- Carrying out calibration test	20 - 21
- Adjusting with the calculator	22
- Sowing Depth	23
- Coulter height setting, tilt setting adjustment	24
- Side Markers	25
- Side marker safety	26
- Tramlining system. Principle, operation	27
- Tramlining System. Settings	28
- Post emergence tramlining	29
- Half width shut-off, Emptying the hopper	30
SECTION 3 OPERATION	
- Field operation, work rate, Drilling into a conventional seedbed	31
- Drilling in wet conditions, Drilling into trashy conditions, Min tillage, Direct drilling	32
- Direct drilling grass, preventing soil compaction	33
- Burying the straw	34
- Other Suggestions	35

SECTION 4	MAINTENANCE	
	- Points 1 - 12	36
	- Cleaning, greasing	37
	- Checking and setting disc coulters	38
	- Checking for signs of wear, Tyre pressures	39 - 40
SECTION 5	OPTIONAL EQUIPMENT	
	- MS Flow modulation. Starting up	41 - 44
	- Operation	45 - 49
	- Variator	50
	- Electro diverter valve	51 - 52
SECTION 6	PARTS LIST	
	- Notes	53
	- Dragarm seeding unit	54 - 55
	- Dragarm axle units. Arable - Grass	56 - 57
	- Drawbar and rear axle assembly	58 - 59
	- Drive wheel assembly	60 - 61
	- Seedbox assembly	62 - 63
	- Seedbox drive unit	64 - 65
	- Multiplier	66 - 67
	- MS Flow modulation	68 - 69
	- Linak Actuator	70 - 71
	- Seedbox metering parts	72 - 73
	- SPI vertical lift marker	74 - 75
	- Electric parts - Sensors	76 - 77
	- Electric parts - Chassis	78 - 79
SECTION 7	CALIBRATION CHARTS	
	- Available pre set reminders	80
	- Table 1. Recommended shutter, base flap and peg wheel positions	81
	- Calibration charts for wheat. Worked example	82
	- Calibration charts for rape, barley, peas and field beans	83
	- Calibration charts for oats, mustard, phacelia and radish	84
	- Calibration charts for lucern, linseed, rye grass and clover	85
	Notes	86
	Warranty	87

A. PREPARATION AND CALIBRATION

Attach the drill to the tractor and raise the drill to its maximum height, remove the transport pins. Calibrate the seeding mechanism for seeds to be sown as in Section 2. Settings.

B. RUNNING IN

If the drill is new and is to be used in cultivated soil, it is better to “run-in” the drill in hard ground, such as a grass field. It is easier to work off the paint and rough edges from the seed tube and disc coulters when working in firm ground as there is more friction to turn the discs. This only requires a few turns across a field without seed. The depth control of the Uni-Drill can be tried out by 1. Retracting or extending of the depth control ram to increase or decrease the depth of penetration. 2. Retracting or extending of the tractor top link if the drill is mounted, Check that all discs turn relatively freely; it may be necessary to slacken off seed tubes that are rubbing tight against the discs.

C. SEEDBED PREPARATION

It is not necessary to prepare a fine seedbed as for other drills. The Uni-Drill prepares its own mini seedbed by using an angled disc and seed tube coulters. In most fields it is only necessary to plough and perhaps level and roll. If the soils are loose, puffy soft or have loose stones on the surface, it will generally be advantageous to roll or press the field first. This will reduce blockages and help maintain even depth control.

Where a fine seedbed has been prepared and it gets wet then the soil acts as a sponge and absorbs a lot of water, making it almost impossible for the drill or any other implement to work in it. Therefore it is better to consolidate loose seedbeds soon after any tillage, so that they will not absorb so much water. The drill will work on most consolidated seedbeds provided the drill is being used at speed. At a speed of over 6 MPH the centrifugal force on the discs and rollers tends to fling the sticky soil from them; just like driving a tractor along a road, where the dirt on the tyres is thrown off when it reaches a certain speed.

Starting up

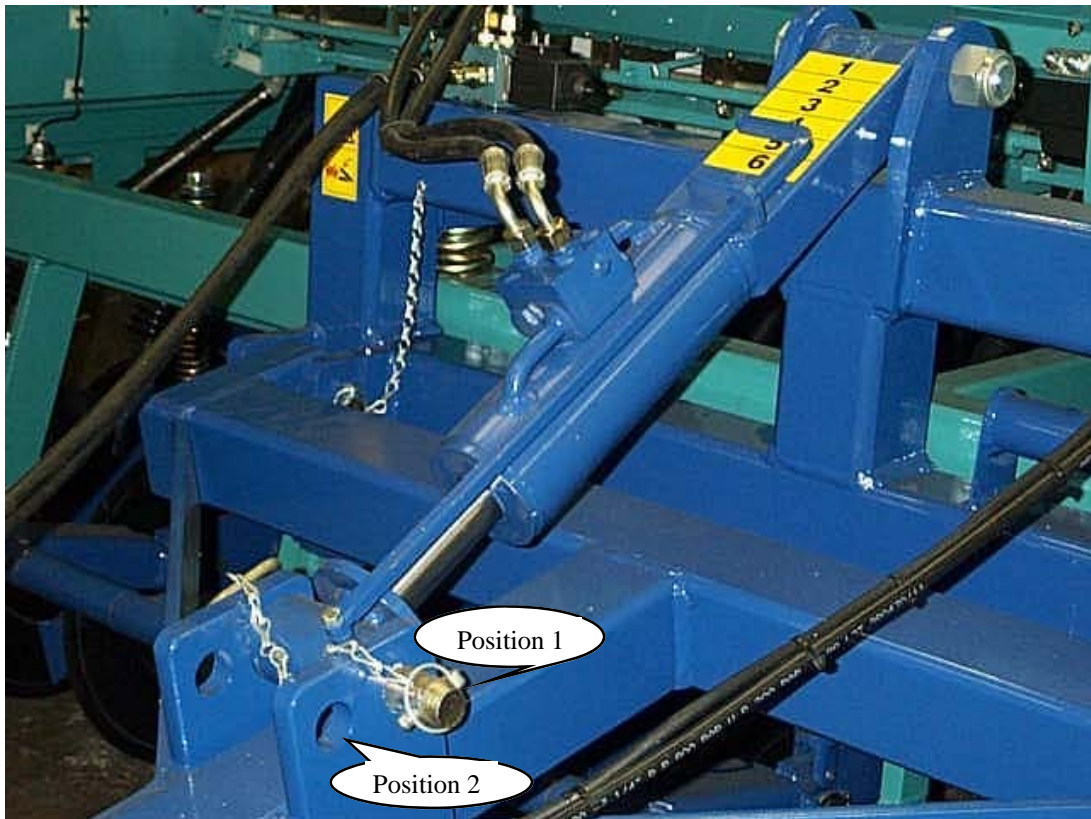

To unhitch the seed drill, set the machine in the working position

HITCHING

Trailed drills

Hitching Height

The height of the hitching point greatly affects the machine's correct operation (+/- 450 mm)

- The hitching point must importantly be fixed. The lower linkage bar cannot be used in this case.
- Low hitching heights should be preferred, such as the pick up hitch or clevis drawbar especially for direct sowing.
- The clevis drawbar is recommended when using dual wheels or wide tyres to make manoeuvres at the field ends easier.

Locking the drawbar

2 drawbar locking positions are available.

- Position **(1)** is the normal working position.
- Position **(2)** is used if position **(1)** is ineffective on hard ground, or if the seed drill's penetration is insufficient.

Starting up 3 Point Linkage Machine



HITCHING

Mounted drills

- 1). When hitching or unhitching the machine from the tractor, place the lift control lever in such a position that the lifting mechanism cannot be activated accidentally.
- 2). When hitching the machine to the three point linkage, ensure that the diameters of the pins correspond to the diameters of the lift arm ball ends.
- 3). Caution! In the three point lifting zone there may be a danger of crushing and sheering.
- 4). Do not stand between the tractor and the machine whilst operating the external lift control lever.

5). When in transport the lift arm stabilizer bars or check chains must be tight to avoid floating and side movement.

6). When transporting the machine in the raised position, lock the lift control lever.

Depth Adjustment

Depth adjustment is obtained by adjusting the length of the tractor top link. As the top link is shortened / lengthened the deeper / shallower the sowing depth can be achieved.

Starting up

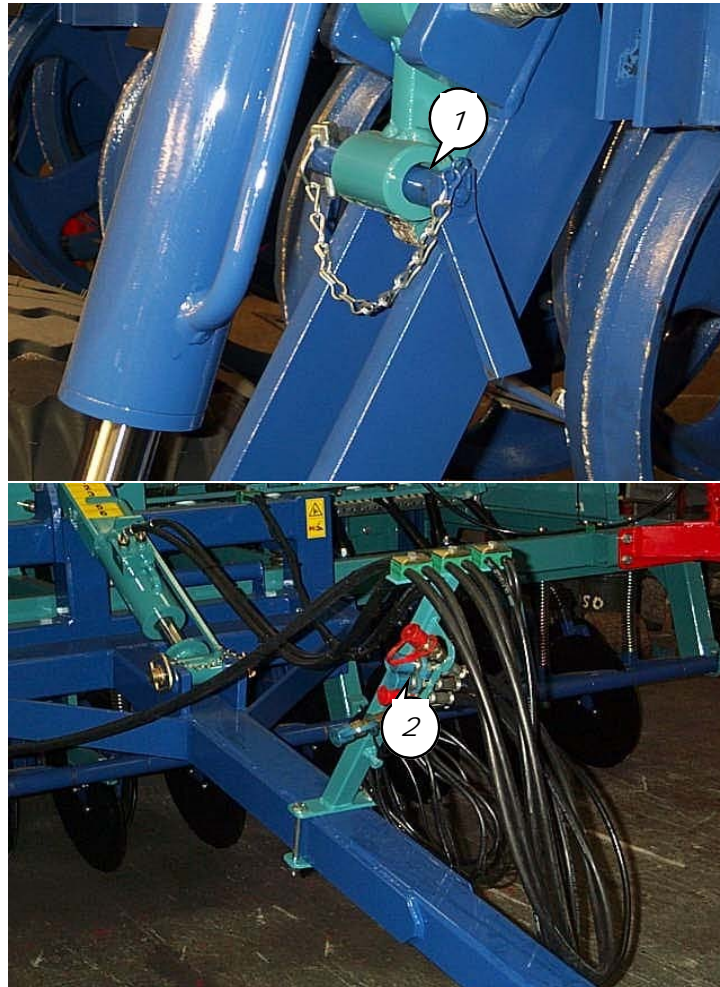

The user must comply with road traffic regulations. The hopper should be empty when driving on the road, at a maximum speed of 25KPH.

TRANSPORT

Positioning the pins (1) in their transport position.

- Raise the seed drill
- Insert the locking pins
- Lower the machine so that it rests on the pins.

HYDRAULIC CONNECTIONS

Double-action hydraulic system to lift the seed drill.

Double-action hydraulic system for depth control

Single-action hydraulic system controlling side-markers and tramlining system.

Install the hydraulic hoses on support **(2)**

The pressure lines are marked with red probe covers.

The return lines are marked with blue probe covers.

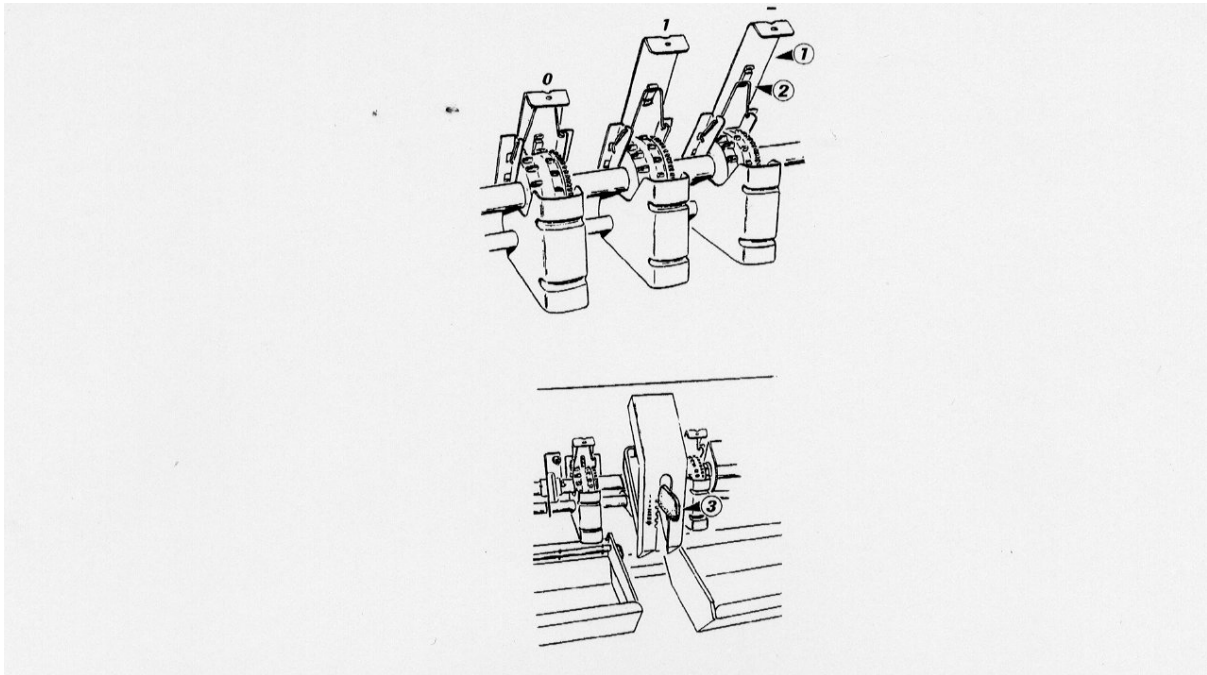

Follow the setting instructions

SETTINGS

Distribution settings. (Please refer to section 5).

1) Distribution shutter.

Raise or lower the shutter **(1)** according to the recommendations. Insert the spring **(2)** into the appropriate catch.

3 opening positions are available for the shutter.

Marker 0. Closed (when sowing every 2nd row for instance).

1. Small seeds < 8kg/ha
2. Large seeds.

2) Base Flap

Move the lever (3) slightly to the right and position at the appropriate marker.

- Marker
1. Cereal. 1st Wheats only.
 - 2.
 - 3.
 4. Peas for canning.
 5. Peas.
 6. Beans.

Max. Lower Position. Hopper Emptying

The aim is to have the seeds metered out by the peg wheel with the base flap open as little as possible (eg marker 1 for wheat and barley). However if you notice constant projections of seed from the distribution system, position the lever one marker above the recommended setting. (eg marker 2 for wheat and barley).

Settings

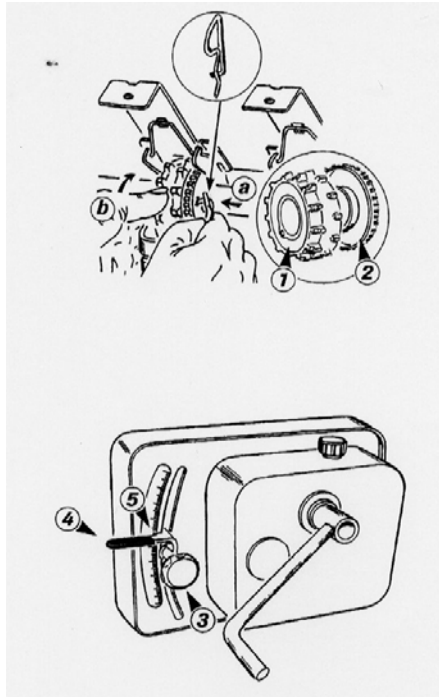

Follow the setting instructions

SETTINGS

3) Selecting the peg wheel

(1) standard wheel for cereal and large seeds.

(2) fine wheel for small seeds

Take hold of the pin located on the shutter of the first unit to the right.

To select the distribution wheel:

A) Press

B) Turn

1. Small seeds < 8kg/ha
2. Large seeds.

4) Variator

Using the knob **(3)** and the lever, position the marker according to the results of the calibration test **(4)**.

Read the settings above the flat part **(5)**

Each marker adjustment must be followed by a calibration test. For your information, 3 graduations on the adjustment scale equals a 10 kg/ha increase/decrease with cereal.

Scale range from 0 to 90.

Settings

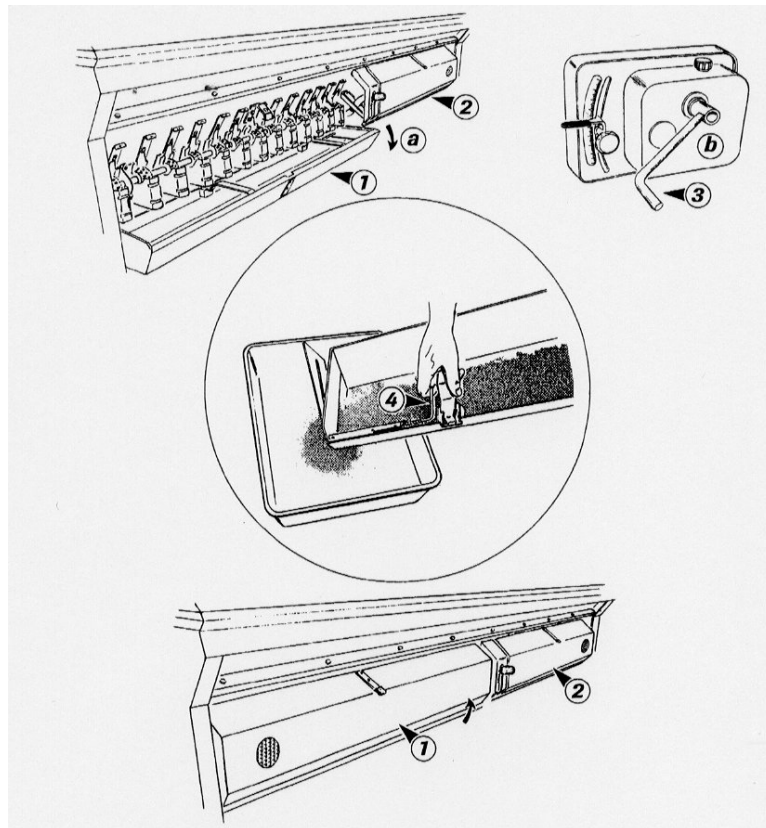

Very precise sowing requires a calibration test. Make sure your scales are accurate.

SETTINGS

Preparing the calibration test

- Use accurate scales and a container.
- Before carrying out the test, check that no-one is standing near the seed drill except the operator.

Procedure

- Open the trays **(1)** and **(2)** and push them down and forward in order to lower them below the distribution points.
- Fit the calibration handle **(3)** onto the variator shaft.
- Check that the distributions in use are engaged.

- Perform your calibration test according to the recommendations issued in the following pages.
- To empty the seeds from the tray more easily, open the flap slightly lifting the lever **(4)**.
- Raise the trays back into guard position.

Settings

1

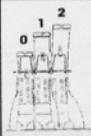
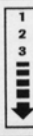
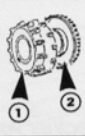
			
Colza			
Rape	1	1	2
Raps			
Luzerne			
Lucern	1	1	1
Luzerne			
Ray grass			
Rye grass	1	1	1
Gras			
Blé			
Wheat	2	1	1
Weizen			
Orge			
Barley	2	1	1
Gerste			
Pois			
Peas	2	5	1
Erbsen			

5

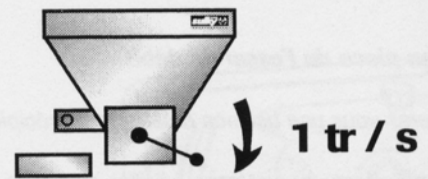

m	2.40	3.00	3.50	4.00	4.50	4.80	5.00	6.00	6.66
tr	62.5	50	43	37.5	33.3	31.3	30	25	22.5

6 - 7

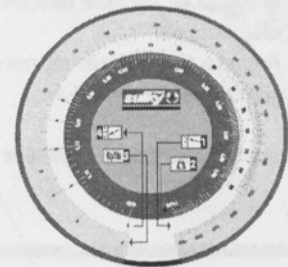

Kg or
x 40 = Kg / ha

2

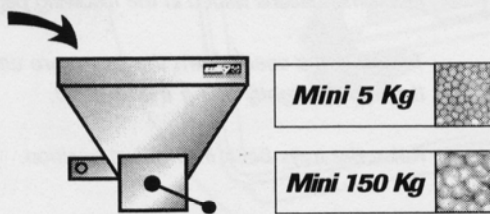

8

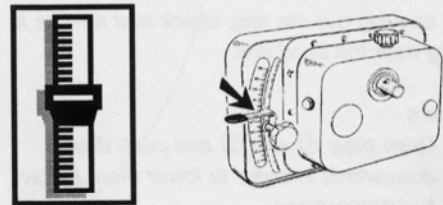

3

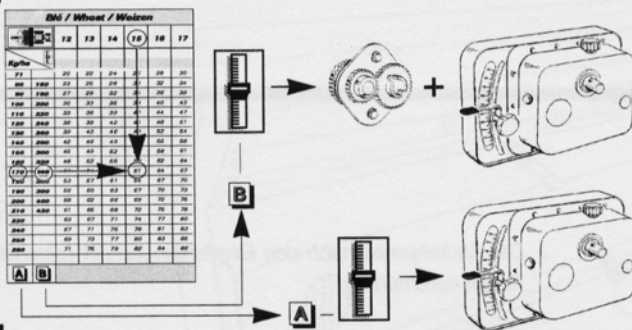

9

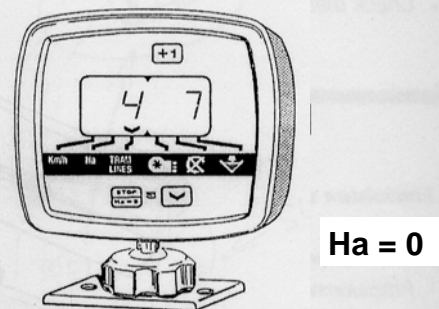

4

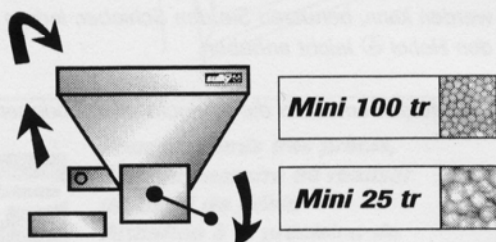

10

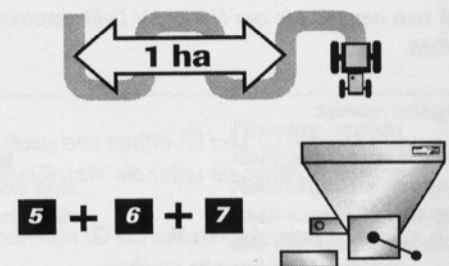

Settings

SETTINGS

C) Carrying out the calibration test

1) Static test

- 1 Set the distribution as described in the operator's manual (Shutters, base flap etc.)
- 2 Put the seeds in the hopper **on the day of sowing** (5 Kg of rape / 150 Kg of cereal) and carry out the following test.
- 3 **Set** the variator at the marker stated in the setting chart section at the back of the manual.
- 4 **Prime** the distribution manually: **a minimum of 25 turns** with the crank (the tray can be filled) if necessary, except for rape (minimum **100 turns**).
- 5 **Carry out** the test by completing a number of turns corresponding to the seed drill's width (turn steadily at **1 turn per second**).
The number of turns for a 3M drill is 50
The number of turns for a 4M drill is 37.5.
(See table below)
- 6 Using accurate scales, **weigh** the quantity collected in both trays.
- 7 **Multiply by 40** to obtain the quantity per hectare or **use the calculator**. (see the following page)
- 8 **Correct** the variator setting (lower the lever completely, then raise it again to the required value).
9. **Reset** the area-meter on the Moore Tronic Pod after the calibration test.
- 10 **The most representative test is one carried out under real working conditions. After sowing a hectare check by carrying out another test. (proceed as above from Step 5).**

Drill Width (Metres)	Number of turns with the crank
3	50
4	37.5

Settings

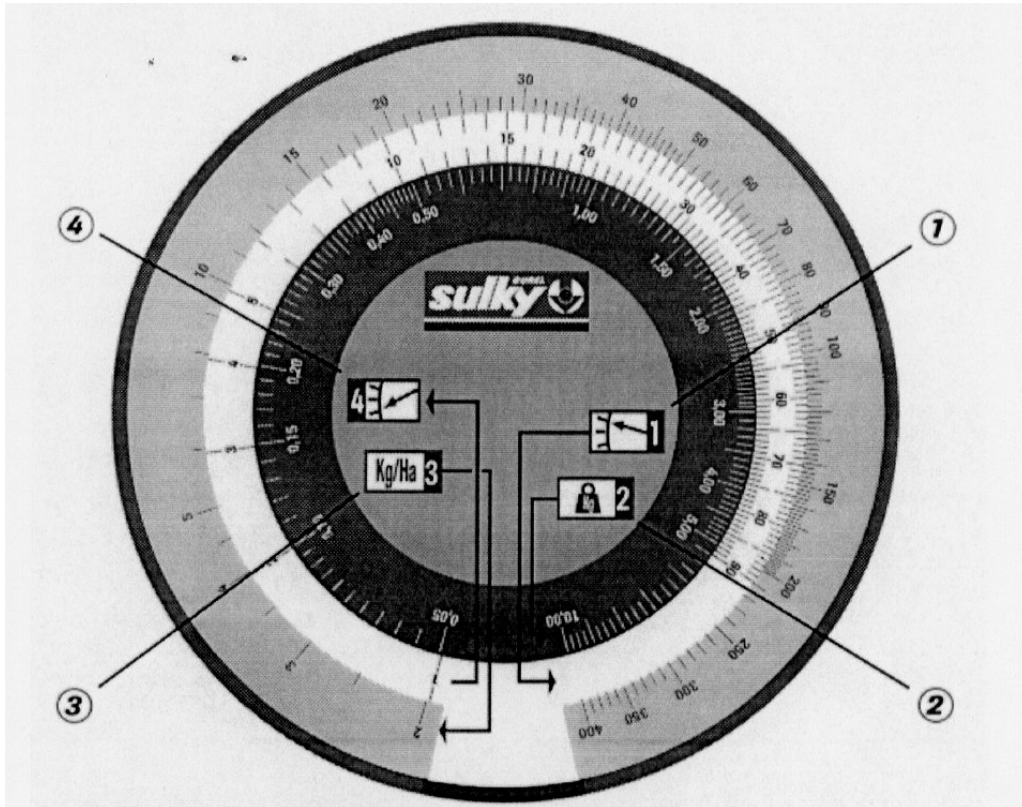

SETTINGS

Adjusting with the calculator

- This calculator enables you to determine the new variator setting after carrying out your first calibration test.
- Adjust the distribution settings and carry out a test according to the recommendations issued in the previous page. Remember to weigh both trays.

Use:

- Match line **(1)** (the variator marker setting used for your first calibration test) with line **(2)**, which corresponds to the quantity (in Kg) collected in the trays during the test.

- Without moving the discs on the calculator, identify the required sowing rate setting on the Kg/ha line **(3)**

- Read the new recommended variator setting off line **(4)**, according to your sowing and tillage conditions.

- After sowing a hectare carryout another check.

- If you wish to change the sowing rate per hectare, using the same seeds, to sow another plot of land, you can use the calculator again to determine the new variator setting, working on the basis of the quantity you obtained for the first calibration test

Settings

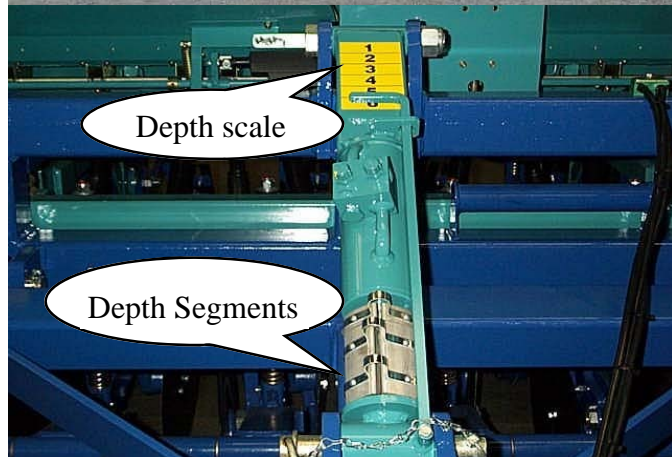

The hitching height and drawbar locking position affect the depth setting's choice. You may need to alter them to reach the required depth setting. (Please refer to the **HITCHING** section).

SOWING DEPTH

Place the ram at its middle position
Use the drawbar ram to set the sowing depth (1) & (2).
Use the yellow graduated scale and depth segments to precisely increase or reduce the sowing depth.

NOTE: 12.5mm depth steps on the ram can be obtained using different combinations of the depth segments

NOTE: Depth segments are not proportional to machine seeding depth.

A Complete depth segment kit contains the segments shown below



1/2" 1" 1" 1 1/2" 2" 4"

Settings

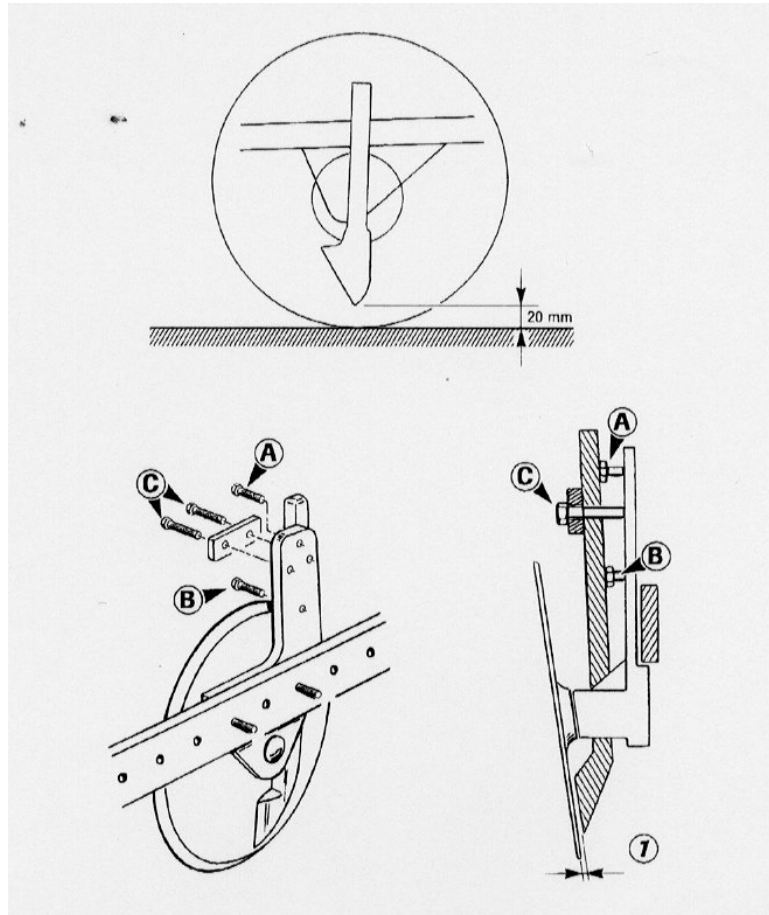

Set the coulters with the machine resting on the ground.

SETTINGS

Height setting

The coulter tip must be set approx. 20 mm back from the tip of the disc.

- It is imperative that the minimum distance is complied with to protect the coulter from shock damage.

This measurement can be finely adjusted by placing a wooden block beneath the coulter with the machine resting on a flat surface.

NOTE: When using the seed drill on very loose or trashy soil it is recommended that you raise the coulter approx. 40 mm above the disc to improve its mobility.

Tilt setting adjustment

The coulter's cutting edge (1) must be:

- Parallel to the disc.
- As close to the disc as possible without limiting it's rotation.

If the disc does eventually block, the coulters settings must be adjusted. By adjusting the tightness of screws (A) and (B), one can either increase or reduce the distance between the coulter and the disc make sure that the coulter's cutting edge always remains parallel to the disc.

- Use the screws (C) to lock the coulter.

Settings

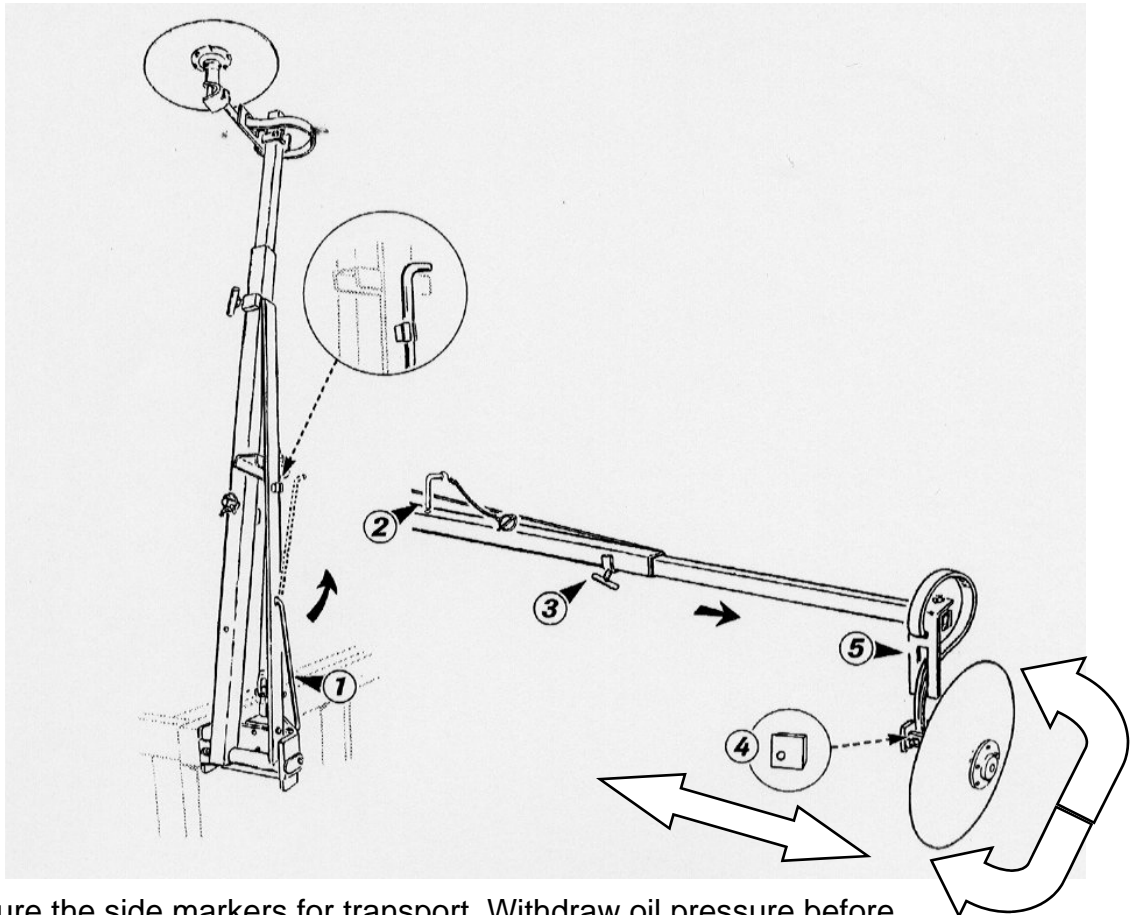

Secure the side markers for transport. Withdraw oil pressure before hitching the seed drill.

SETTINGS

Side Markers

- Setting the markers in their working position.

The markers are designed for marking at the centre of the tractor.

Apply pressure to the hydraulic circuit. Remove the locking levers **(1)** for transport.

- Lower the first marker arm and extend the inner arm.
(remove the pin **(2)** and loosen the screw **(3)** this allows for infinite horizontal adjustment of the marker arm.
- The discs vertical setting may be altered in order to increase or reduce ground marking depth.

Four settings can be applied by alternating the position of the disc orientation block **(4)**

- If you wish to alter this setting move the disc support **(5)** along the tube.
- The distance from the final sowing to the disc equals half the working width plus half the spacing.

For example $16.6 / 2 = 8.3$ cm.

Settings

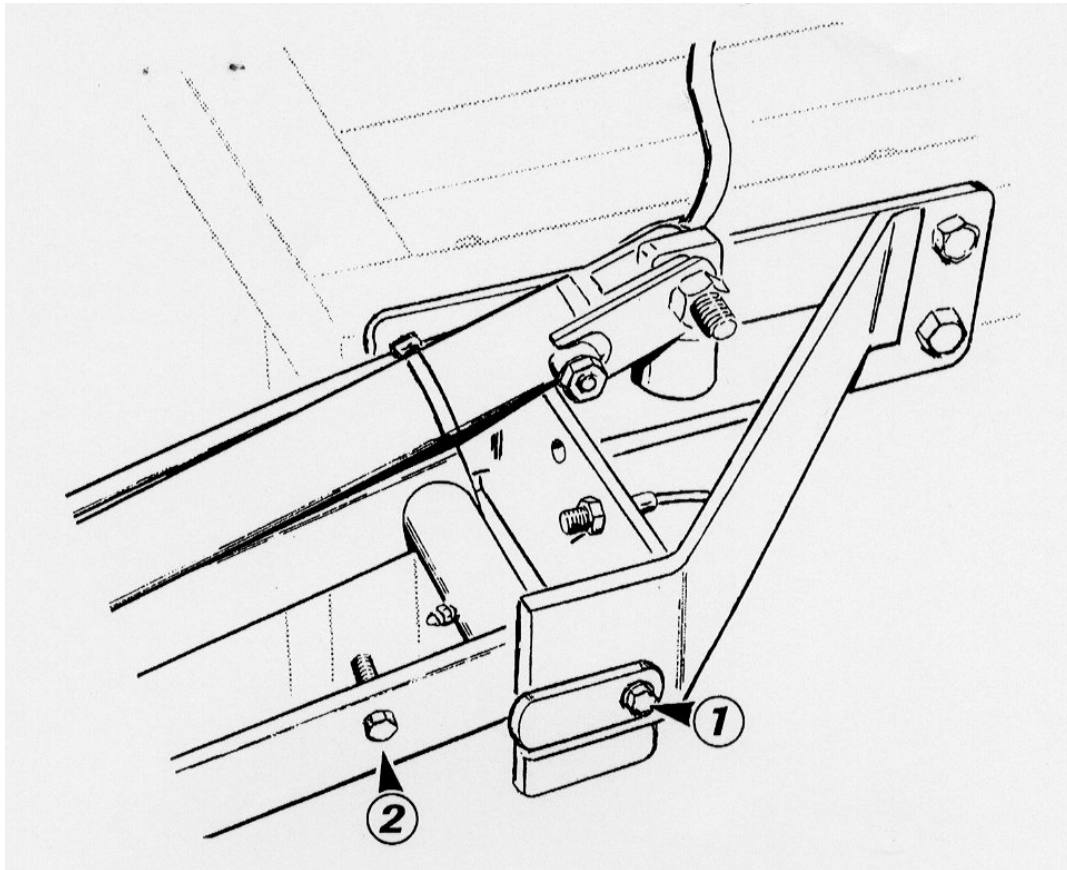

The markers must be raised smoothly. Manoeuvres at field ends must be performed with the markers raised. During transport: shorten the arms if the overall height is a handicap.

SETTINGS

Safety

The marker safety devices only operate in the working position.

Active Safety = Flexible tine buffer between the arm and disc.

Passive Safety = M8 x 40 class 6.8 safety shearing bolt **(1)**.

Replacement bolt **(2)** on arm rib.

Operation

Apply pressure = Both markers are raised.

Release pressure = One marker is lowered.

Apply pressure = The lower marker is raised

Release pressure = The other marker is lowered

Settings

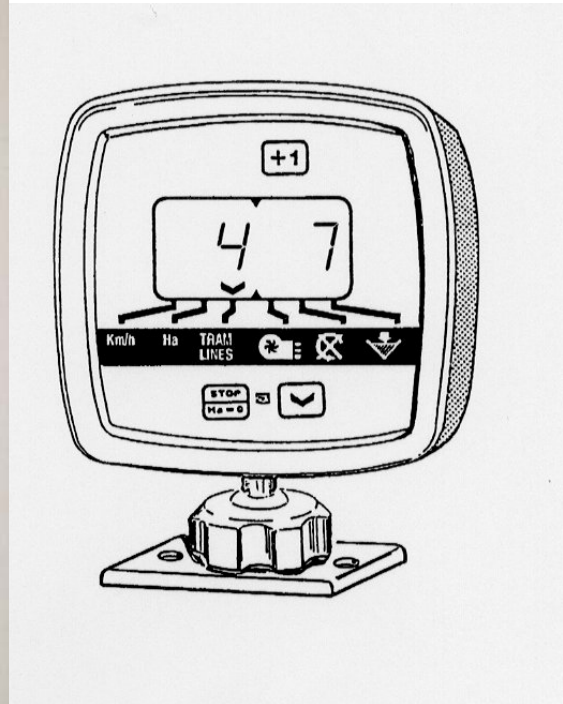
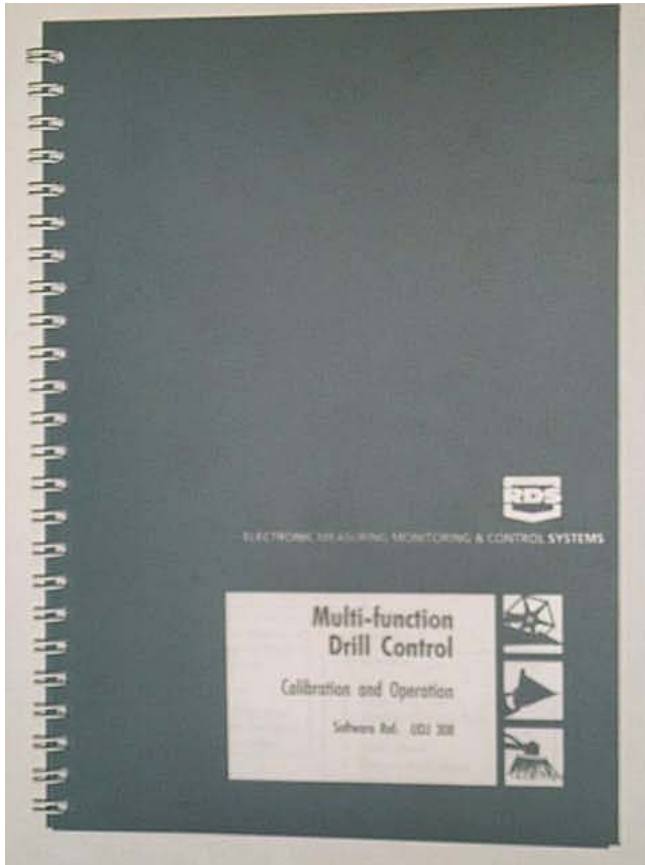

For correct operation of the tramlining system make sure electrical connections have been made correctly.

Calibration and operation for the Moore Tronic Multi-function Drill Control can be found in the RDS Manual Issue 4. Software reference UDJ 308.

SETTINGS

Tramlining system

Principle.

- Its purpose is to create tramlines with a view to future treatments using machines whose width is a multiple of the seed drills working width.

Operation



Post emergence tramlining.

- 2 to 4 seed metering wheels can be disengaged to match the width of the wheels in the tramlines for future applications with the fertilizer spreader or sprayer.
- Electronic control.

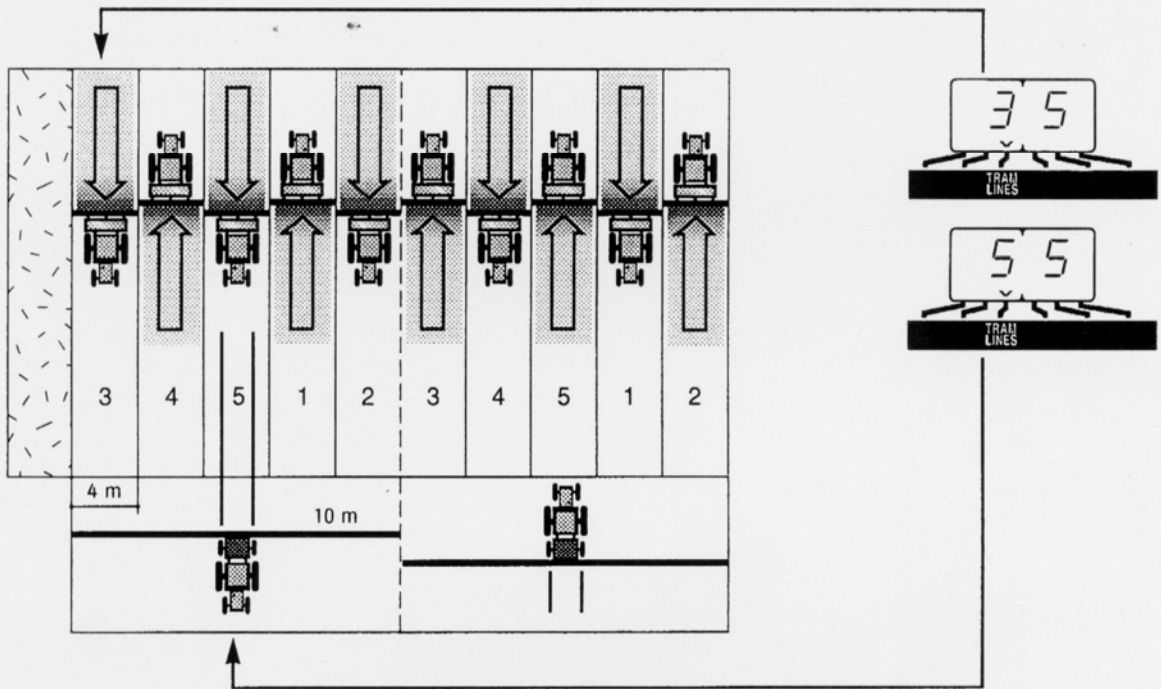
Settings

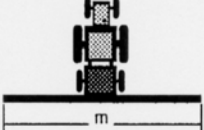
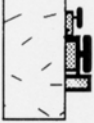

SETTINGS

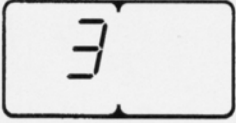
 m	 m			
3	9		3	2
	12	•	4	2
	15		5	3
	18	•	6	3
	21		7	4
	24	•	8	4
4	12		3	2
	16	•	4	2
	20		5	3
	24	•	6	3
	28		7	4
	32	•	8	4
	36		9	5

Settings

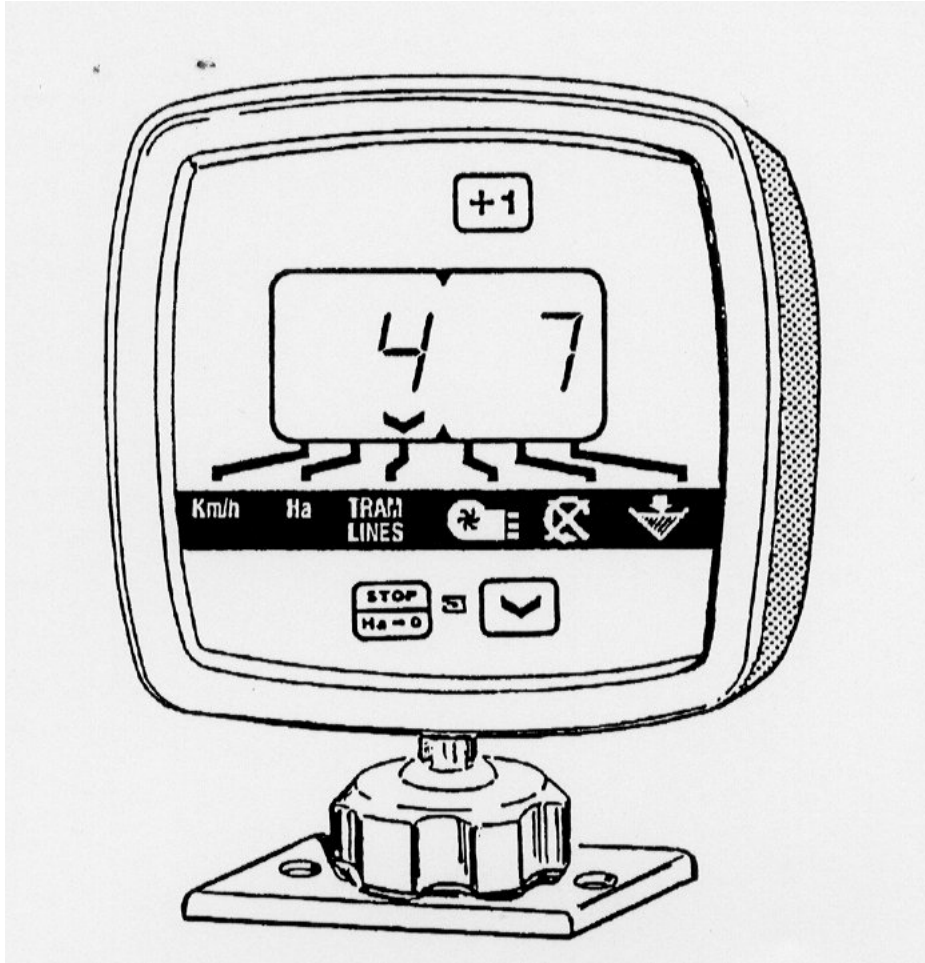

Apply pressure to the hydraulic distributor's lever for a few seconds

SETTINGS

Post-emergence tramlining

When Marking:

Pull the hydraulic spool lever to reverse the markers. When lowering the markers hold the hydraulic distributor lever down to empty the circuit. The markers are raised under pressure.

To change tramlines move the seed tubes to the corresponding rows.

- Electronic controls

- The principle of automated control is based upon the operation of the markers at field ends; raising the seed drills in mid field for instance does not alter tramlining settings.
- To operate the unit, please refer to the MOORE TRONIC operator's manual.

Settings

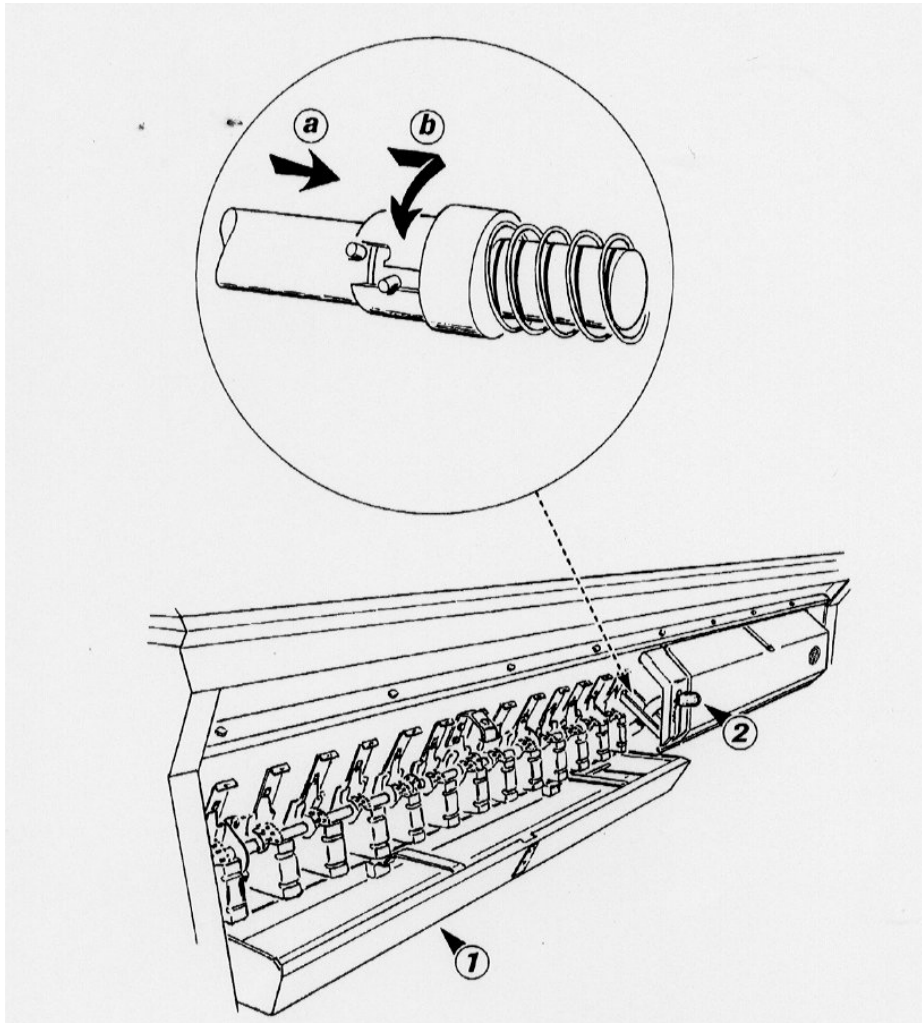

It is important that the hopper is emptied after sowing to avoid any damage caused by rodents

SETTINGS

Disengaging half the seed drill (1/2 width shut off)

- The central coupling between the distributor half-shafts can be uncoupled in order to match the current tramlining setting. Only the left hand side can be disengaged.
- To disengage
 - **(a)** - Press
 - **(b)** - Turn

Emptying the Hopper

Emptying the hopper into tray **(1)**.

Lower the trays beneath the metering device and push the lever **(2)** down fully.

To interrupt the seed flow when the hopper is only partly empty, raise the lever very slightly, without raising it to its upper position.

A. FIELD OPERATION

Do not turn sharp corners with the Uni-Drill especially in direct drilling operations as this will give massive disc to soil side thrust. When this happens the disc is parted from the seed coulter and trash can then enter between them resulting in blockage to the seed flow. It is better to lift the machine out of and into work when turning corners.

B. WORK RATE

As there is no disc bounce due to the high inertia coulter system with press wheels, relatively high ground speeds can be tolerated giving high work rates. (11 - 15 Km/hr). The operating speed and the quality of work which results is controlled by field conditions but where ever possible a steady speed should be maintained. As field conditions vary, it may be necessary to adjust the coulter settings to maintain seed depth and cover.

C. DRILLING IN A CONVENTIONAL SEEDBED

When working in cultivated soil, most of the drill weight is carried on the press wheel Rollers and tractor drawbar. Seed depth can be obtained by Extending or retracting the depth control ram. The soil is usually tracked to the depth required by the disc seeding units and consolidated by the press wheel rollers - this gives excellent seed soil contact equalling ideal conditions for seed germination.

It is recommended that the centre of the field should be drilled first and the headlands last. If the headlands are planted first then the tractor and drill will travel and turn on planted ground, thus disturbing, compacting and moving seeds that have been placed at a constant depth. Check the seeding depth in the field and on headlands, remember the headlands tend to be more consolidated than the remainder of the field. If headlands are drilled last the field is left tidier on completion.

On rougher types of seedbed the drill itself tends to be self levelling. The seed tube and disc coulter units tend to move the soil from humps to hollows. **IT IS NOT NECESSARY TO HARROW AFTER SOWING.** Harrowing will move seeds either shallower or deeper thus giving uneven germination. Remember seeds that are planted two to three inches deep take about two weeks longer to germinate and appear as weak plants, that are under stress and are susceptible to disease and slugs

If rolling behind the drill on lighter soils is thought to be beneficial, remember that the seed has been accurately placed at the ideal depth for early and even emergence. Rolling will tend to flatten the ridge of soil between each press wheel mark and will in fact add to the soil cover over the seed thus slowing emergence and probably reducing vigour. This extra soil cover over the seed must be allowed for, when deciding drilling depth when starting the field.

Operation

D. DRILLING IN WET CONDITIONS

The Uni-Drill is fitted with adjustable scrapers for the press wheels. Wet Soil will usually build up to about one inch on any wheel. Adjust the scraper so as to knock off the excess soil that would build up over the normal amount of soil that sticks to the press wheels. Leave a gap of 15 to 20 mm between the scraper and the press wheel. Never reverse the drill with the seed tube coulters in the ground as this would block the seed outlets with soil. Where there are very wet pockets of soil in some fields, the road wheels can be used to slightly raise the drill out of the ground thus assisting the drill to drill high; always keep the drive wheel in contact with the ground. Speed is the biggest aspect, below 7 km/hr the disc coulters will tend to block above 9 km/hr is the optimum for drilling.

E. DRILLING INTO STRAW INCORPORATED SOIL AND TRASHY CONDITIONS

In heavy trash conditions it may be necessary to raise the tip of the seed tube coulter so that the disc will cut through the trash before the coulter opens the slit. In heavy maize trash, especially in the direct drill or no-till situation, it may be necessary to raise the tip of the seed tube coulter 30 to 40 mm above the edge of the disc. The discs cut through the trash very positively. The weight of the press wheels keep the discs anchored and do not allow the discs to ride out of the soil, even when there is a lot of trash present. Bulldozing normally occurs when a disc meets trash, tries to ride up over the trash, then pushes it in front of the disc, thus causing bulldozing and blockages. If this happens it is usually due to the soil underneath being too loose. The drill will cut cleanly through, given that it has something to "bite on". Consolidating the field with either rollers or a land packer, sufficient to allow the drill's discs to turn, will usually cure the problem. A speed of 9 - 11 Km/hr works, 7 - 8 Km/hr doesn't.

The trash itself especially chaff, on decaying, produces acids, toxins, etc., which tend to damage or kill the germinating seed. If the trash is mixed with the soil and consolidated tightly to give a good straw/soil contact then the soil will absorb the toxins as they are formed, before they can harm the germinating seedlings. The press wheels on the UNIDRILL consolidated the trash, soil and seed in exactly the right manner to give very healthy plant stands even in the heaviest incorporated residues. If straw is incorporated into the soil to leave a loose fluffy seedbed then it must be consolidated first using either a roller or land packer, etc., before drilling.

F. MINIMUM TILLAGE AND DIRECT DRILLING

In certain soils, especially if they contain stone or brash, it is recommended that the top 1" or 2" should be cultivated or scratch tilled. This will encourage the germination of volunteer cereals and weed seeds. It will also help to level out the tramline and wheeled tracks. Also if stones are left undisturbed in the top layer, they become embedded and the disc will ride from stone to stone without getting good penetration.

In soft field conditions it is essential to set the discs deep enough to cut through all the mat or surface trash. Seed will germinate and grow better when in contact with the soil. In wet, soft conditions the disc may be set to penetrate deeper than required. As the drill moves forward the seed is trapped by the sides of the slit and do not necessarily fall to the bottom of the slit.

Operation

G. DIRECT DRILLING GRASS PASTURES.

Four methods are suggested for direct reseeding grass into grass pastures.

- A. If the pasture has been badly poached or there are bare patches due to frost kill etc., over the winter, about 110 Kg/Hectare of a vigorous growing type of grass (e.g. Italian Rye Grass) should be drilled just before growth starts (March / April).
- B. Where a first cut or second cut of silage is being taken, cut low to the ground and direct drill the new grass mixture the next day. There should be enough moisture retained in the soil to germinate the seed and get it growing before the cut sward can fully recover.
- C. Graze the pasture as bare as possible, then spray Gramoxone (1.4 Litres/Hectare) and direct drill the new seed mixture. The Gramoxone used at a low rate will not kill all the old grass sward but should retard its growth sufficiently to get the new seeds established.
- D. Where the old pasture is very weedy and a complete reseed is required, spray with Roundup to get a total kill of vegetation. Leave the field for the recommended period and direct drill with the new seed mixture. To get a better grass cover, cross drilling at an angle (30 - 45 degrees is recommended, especially with the wider row spacing UNIDRILLS. Check the reseeds for Leather Jacket, slug or fruit fly damage and treat accordingly. Grass sown after 1st August should be sprayed with pre-emergence with Dursban or Spannit to protect from fruit fly and leather jackets. Slug pellets should be used as required.

H. PREVENTING SOIL COMPACTION

1. **Whenever possible, use low-pressure tyres on all machines operated in fields in order to reduce superficial compaction**

Mounting wide tyres or dual wheels is not enough, the tyre pressure must be adjusted accordingly. Aim for 0.6 Bar, according to the tyre manufacturer's recommendations. As the UNIDRILL is a towed seed drill, it exerts no weight on the rear tractor wheels and does not require counterweights to be mounted at the front.

2. **Reduce the load per axle to avoid in-depth soil compaction.**

Avoid loads over 6 tons per axle, if heavier trailers must be used, park them at the field entrance. Prefer lightweight trailers, as the UNIDRILL requires little tractor power, moderately powerful - and therefore light weight - tractors are sufficient.

3. **Till on dried-out ground.**

Be patient and wait for the right time of year before starting tillage. According to scientists as soon as drying soil changes colour, it acquires resistance to compaction. After 4 or 5 years of conservation tillage, the ground drains water faster and becomes more resilient, which reduces the necessary waiting time. More humus in the soil increases its ability to carry weight without compacting

4. **Provide calcium and magnesium to compensate the grounds eventual acidity.**

Aim to maintain a PH of 6.5 - 7 to ensure optimal stability of the clay-humus compound.

5. **Enrich the soil with organic matters to preserve it from compaction and to increase its resilience.**

Leave straw and culture residues on the ground, spread manure, grow fodder plants and avoid power harrowing.

1. BURYING THE STRAW

1. **Select a suitable variety.**

According to the selected variety, the quality of produced straw can vary as well as its shock resistance. A variety that is resistant to illness and does not imperatively require fungicidal protection at the end of the season will also be more easily decomposed by the fauna in the soil. A late Spray of Round up is recommended.

2. **Prepare and adjust settings on the combine harvester**

Tightening the thresher and increasing the rotational speed will help to break the straw and help to spread it better. Dry straw breaks more easily under these conditions, harvest the fields that you wish to sow first. The combine harvester must be imperatively equipped with a chaff spreader. Shred the straw into chaff of 5-6cm (sharpen the shredder blades, tighten all belts) and spread evenly. Don't drill into poorly spread chaff.

3. **Shred the chaff and stubble behind the combine harvester**

In particular, if the catch-crop period is short, the cutting level is high, the chaff is poorly spread out and you wish to till the soil with tools fitted with tines.

4. **As soon as the sowing is finished, keep clean and strong crops growing together.**

Use clean seeds that are free of weeds and have a high germinal power. The seeds must be placed to obtain a fast and even growth, to create a culture that will be able to compete with weeds and have a high germinal power.

5. **Use a seed drill which causes little disturbance of the soil such as the UNIDRILL.**

The UNIDRILL works exclusively in the sowing line, which avoids seeds that escaped the stale seed bed from emerging. Prefer wide spacing between rows such as that of the UNIDRILL (16.6 cm).

6. **Watch for the evolution of the flora during the cultures' growth period**

With conservation tillage, the usual weeds do not appear in the same quantities or at the same dates: additionally, new species may appear. Prepare for this evolution by improving your botanical knowledge. Every week while the crops are growing, walk through the fields moving into plots of land in a continuous series of "Ws", identifying plants and their respective development, write any observations down and trace the history of each plot of land.

7. **Use herbicides of new chemical categories every year**

Using different Chemicals each year will help avoid crops becoming resistant to the chemicals.

8. **Clean borders, fallows and crops before the heading**

Cut or shred weeds on embankments, in ditches and in fallows rather than treating them with total herbicide, some perennial plants might not react to the product and may then become difficult to get rid of. Some find it preferable to grow rye-grass on boarders. It chokes weeds and can be easily kept under control using a mower. During the season destroy the remaining localised weed growth spots using localised treatments, using a strimmer or by hand.

9. **Avoid scattering weed seeds when harvesting.**

Start harvesting the cleanest plots of land. In weed-infested plots, harvest the cleanest parts first. Clean the combine harvester well after harvesting weed-infested land.

Ploughing is a last resort if the above techniques are not sufficient enough to get rid of annual grass or dicotyledons.

J. OTHER SUGGESTIONS

(i) Pre– Emergence Marking. (If no pre-emergence marker is fitted)

Once the operator is used to the hydraulic system operating the transport wheels, the wheels can be adjusted to just make a mark on the soil behind the drill. This can be easily followed for pre-emergence chemical applications. This is achieved by activating the float position on the spool valve whilst on the tramline bout.

(ii) Pre loading Dragarms

If it is noticed that during drilling, the coulters behind the tractor wheels are not drilling at the same depth as the rest, the dragarms on these coulters can be preloaded by placing washers or similar spacers between the front spring - lower and the spring locating bush.

1. Before all maintenance, service or repairs and when trying to identify a breakdown or malfunction you must ensure that the power drive is disconnected and that the engine is switched off and the ignition key removed.
2. Check Tightness of screws and nuts. Retighten if necessary. (Especially Transport Wheels).
3. Before maintaining a machine in the raised position, support it by appropriate means.
4. Before replacing a working part, wear protective gloves and only use the appropriate tools.
5. To protect the environment, it is forbidden to throw or pour out oils, grease and filters of any description. They should be given to firms specialising in their disposal.
6. Before undertaking any electrical work on the tractor or attached machine disconnect the alternator cable and the battery.
7. Protective covers which are prone to wear should be checked regularly. Replace immediately if damaged.
8. Spare parts must conform to the manufactures specification. Only use genuine Moore parts.
9. Before working on any electrical circuit disconnect the power source.
10. Repairs carried out on parts under tension or pressure (springs or components under pressure etc) require specialist knowledge and tooling so should only be carried out by qualified personnel.
11. In the winter time leave the base flap fully open so any rodents can escape otherwise they will chew through a peg wheel to get out.
12. Do not leave any seed in the machine after the drilling season is finished

Maintenance

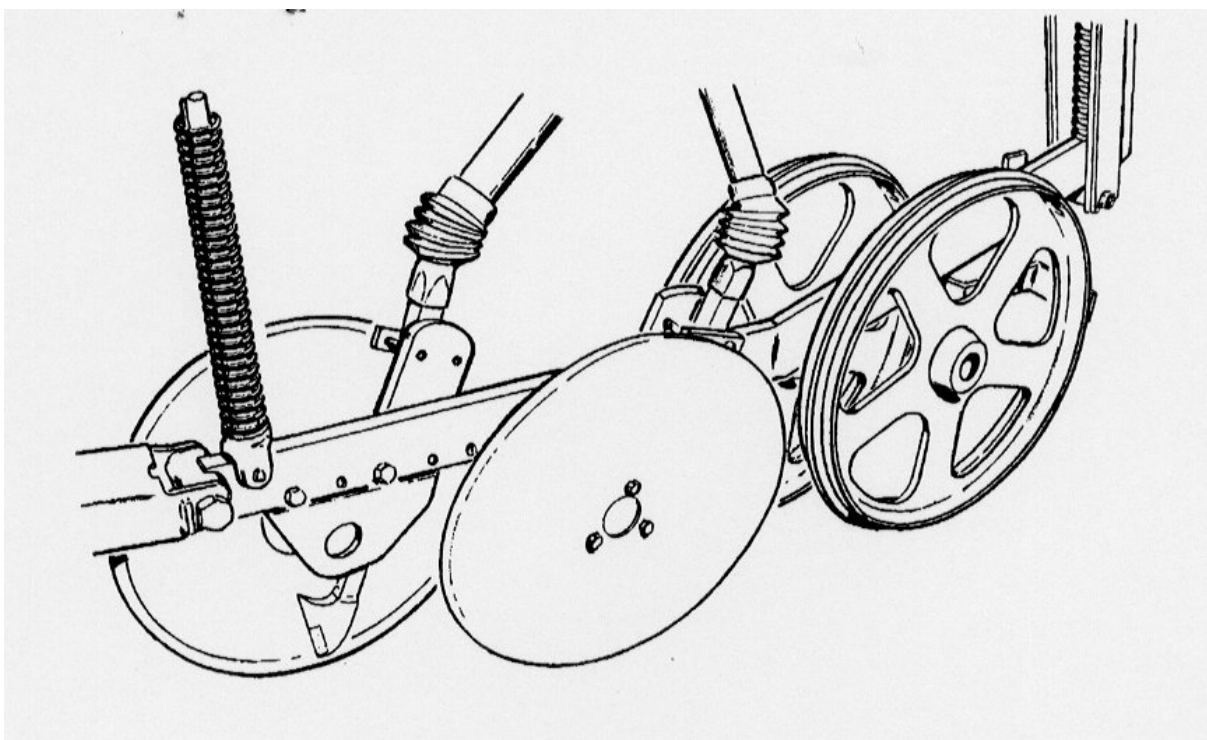

Change the oil in the variator gearbox every 500 ha or every 2 years at the most. Never grease the metering devices or the coultter tubes.

Maintenance

Cleaning

Cleaning the inside of the hopper and metering system.

Clean the seed drill

High-pressure cleaners are liable to cause damage to bearings and electrical circuits!

Greasing

Grease the machine (Markers) at the beginning and end of the season using standard agricultural grease. Grease the markers every 20 hours there after.

Lubricate the tramline clutch springs by spraying with penetrating oil.

Lubricate the drive chains.

Check the oil level in the variator (with the seed drill horizontal), and top up to the red dot with ATF DEXTRON 11 D Automatic gearbox oil.

Change the oil in the variator every 500 ha or every 2 years.

Maintenance

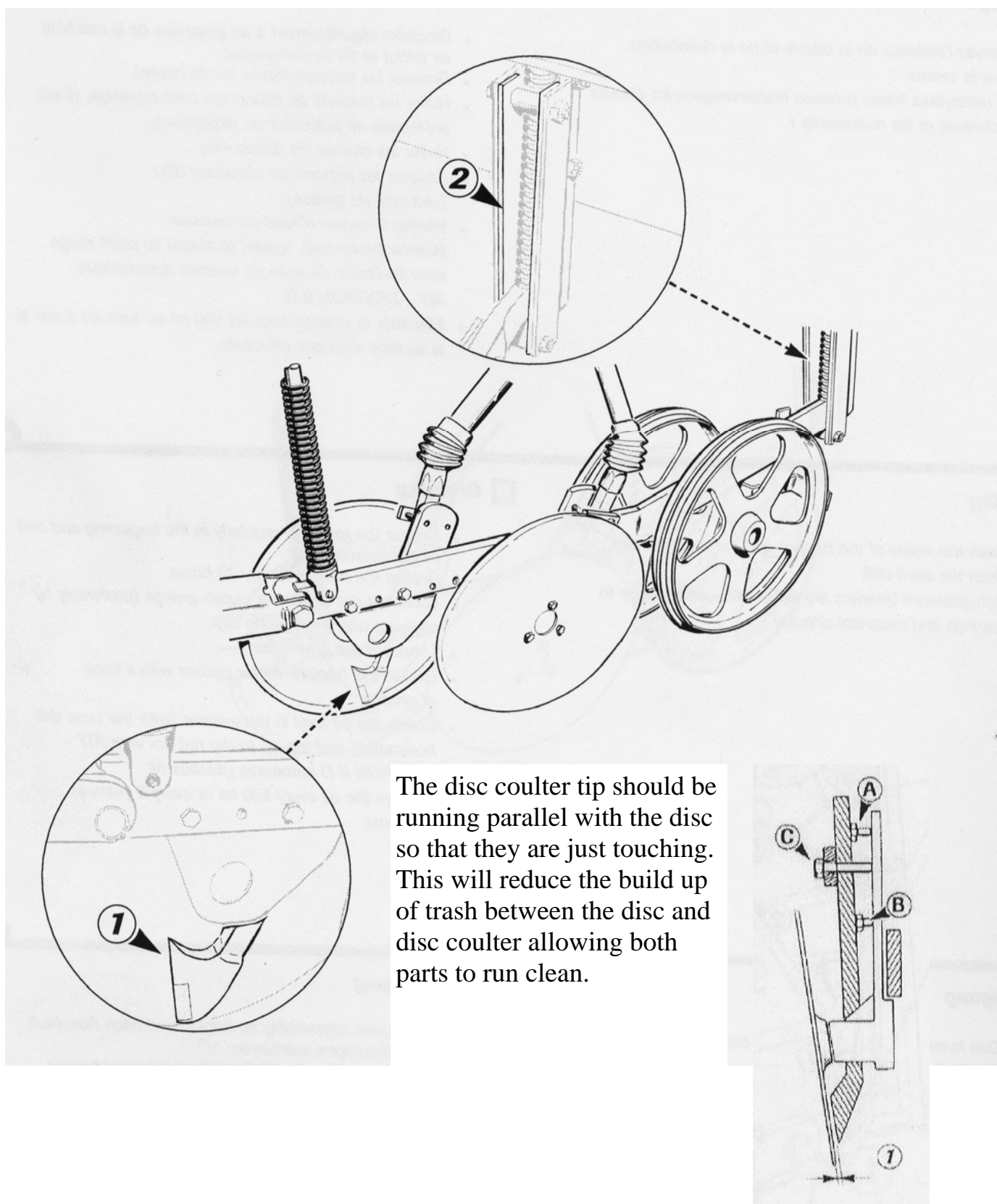

The disc coupler tip should be running parallel with the disc so that they are just touching. This will reduce the build up of trash between the disc and disc coupler allowing both parts to run clean.

Carry out these checks regularly, particularly when using the seed drill on hard or rocky soil.

Maintenance

C) Checks

Check the following signs of wear

Coulters (1)

These are essential parts of the sowing device and must imperatively have an aggressive shape.

“Charge weld” them before excessive wear Occurs.

Rear guiding plates (2) of the drag arms. (ref: 213-1234)

Never lubricate or grease these parts

Mount the guiding plates upside down or change them if they become too thin.

Check the tightness of the following parts:

- After 20 hours of use:
Check the tightness of the main bolts.

- After 10 hours of use:
Check the tightness of the disc mounting bolts (disc fastening screws) and the tapered hub bearings.

If these bearings grow loose they must be tightened.

- Remove the bearing’s dust cap.
- Tighten the bolt until the disc’s rotation becomes difficult.
- Loosen the bolt a quarter of a turn. Always use loctite

Regularly check the tightness of the wheels and the tyre pressure.

Tyres: 400/60 - 15.5 = 1.75 Bar
 19.0/45 - 17 = 1.5 Bar
 10.0/75 - 15.3 = 2.25 Bar

Tyre pressure chart for 19.0/45 - 17 Vredestein Tyres

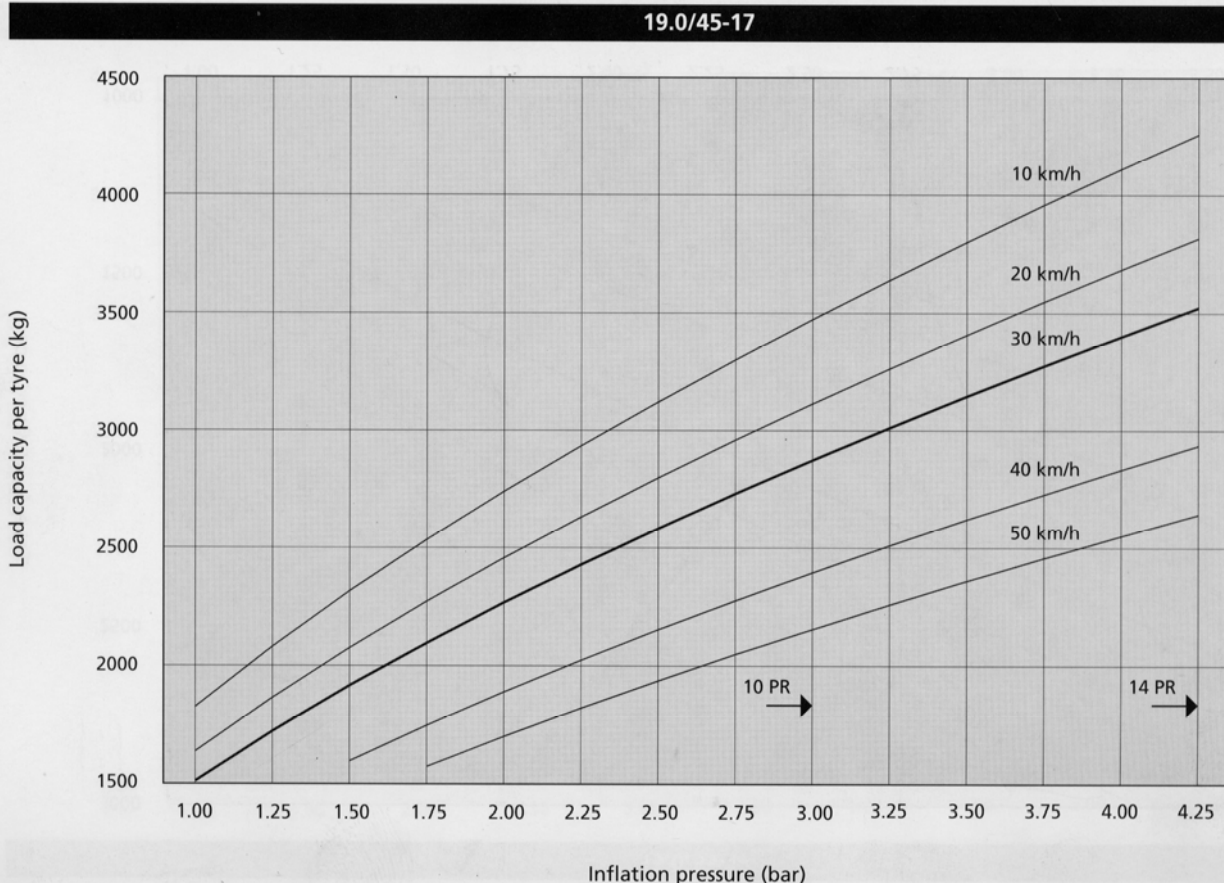

Maintenance

Tyre pressure chart for 10.0/75 - 15.3 Vredestein Tyres

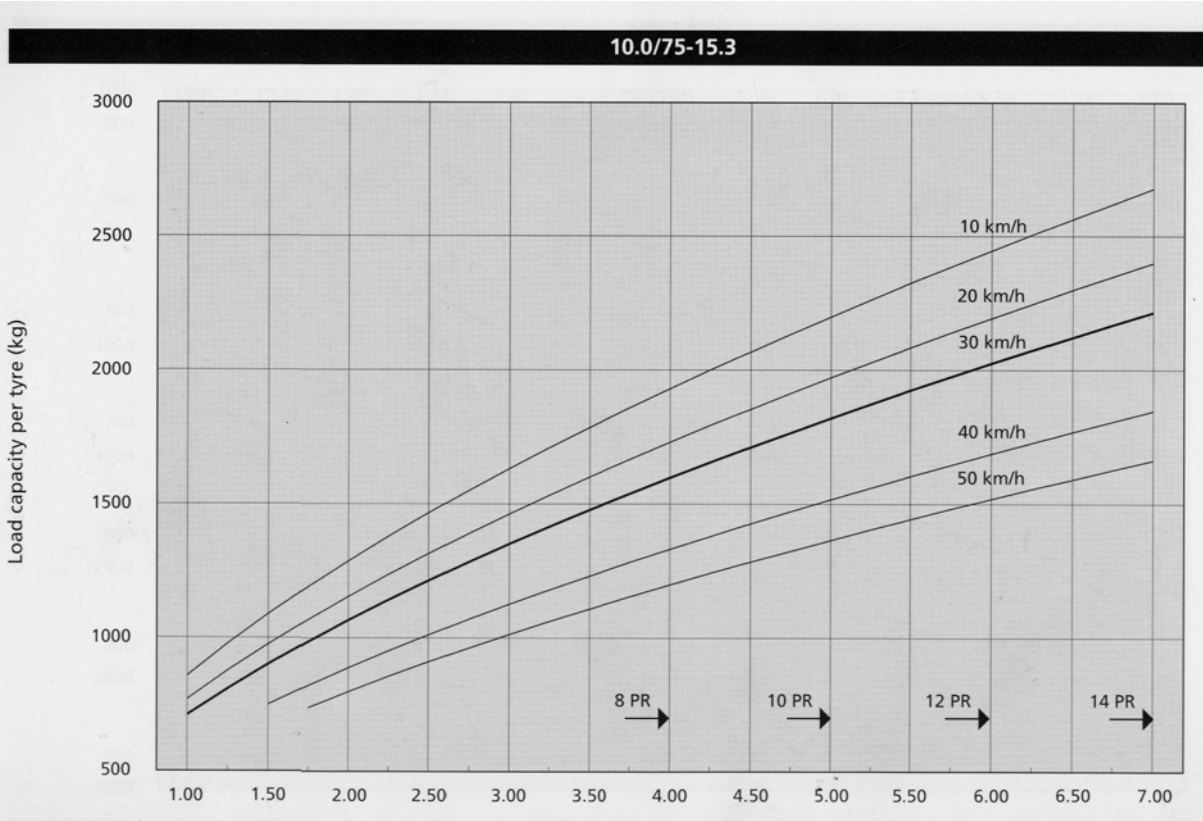

MS Flow Modulation

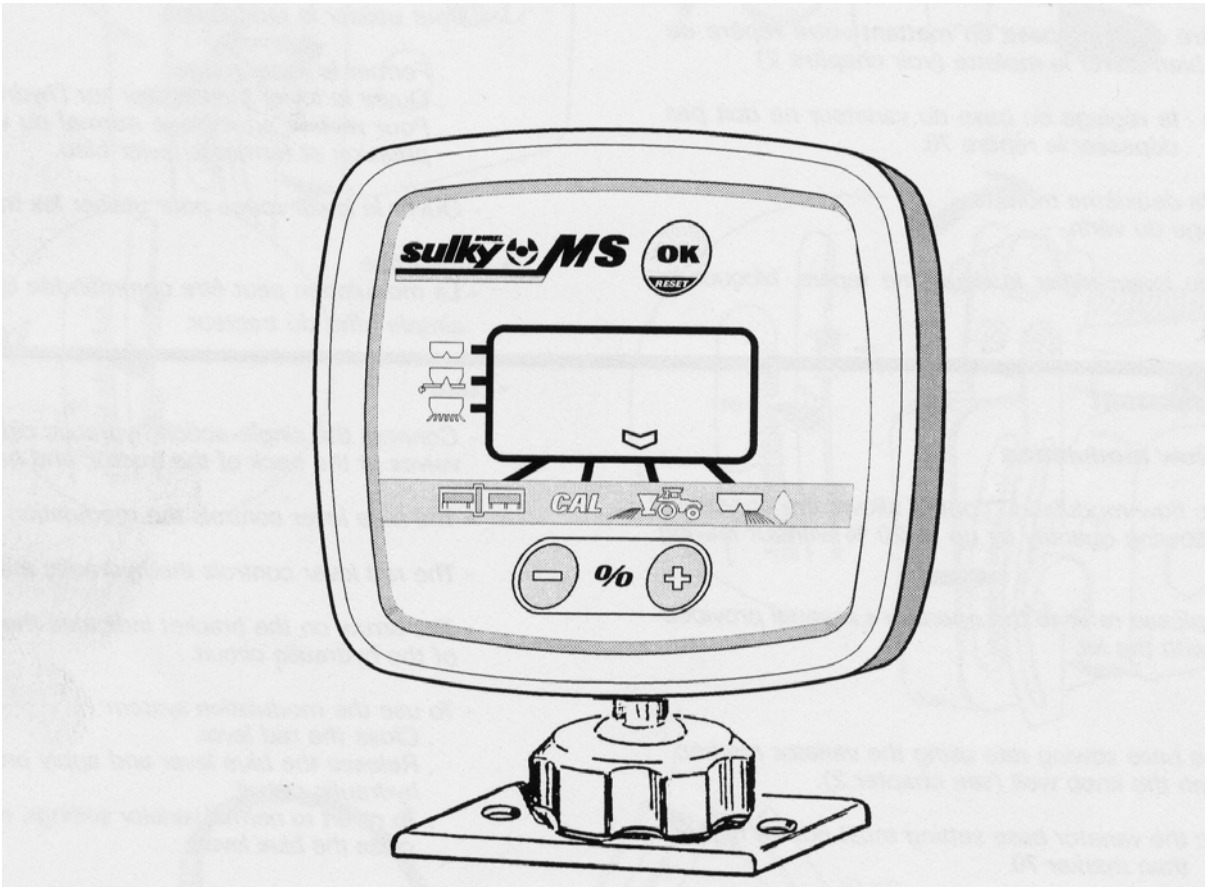

Starting up

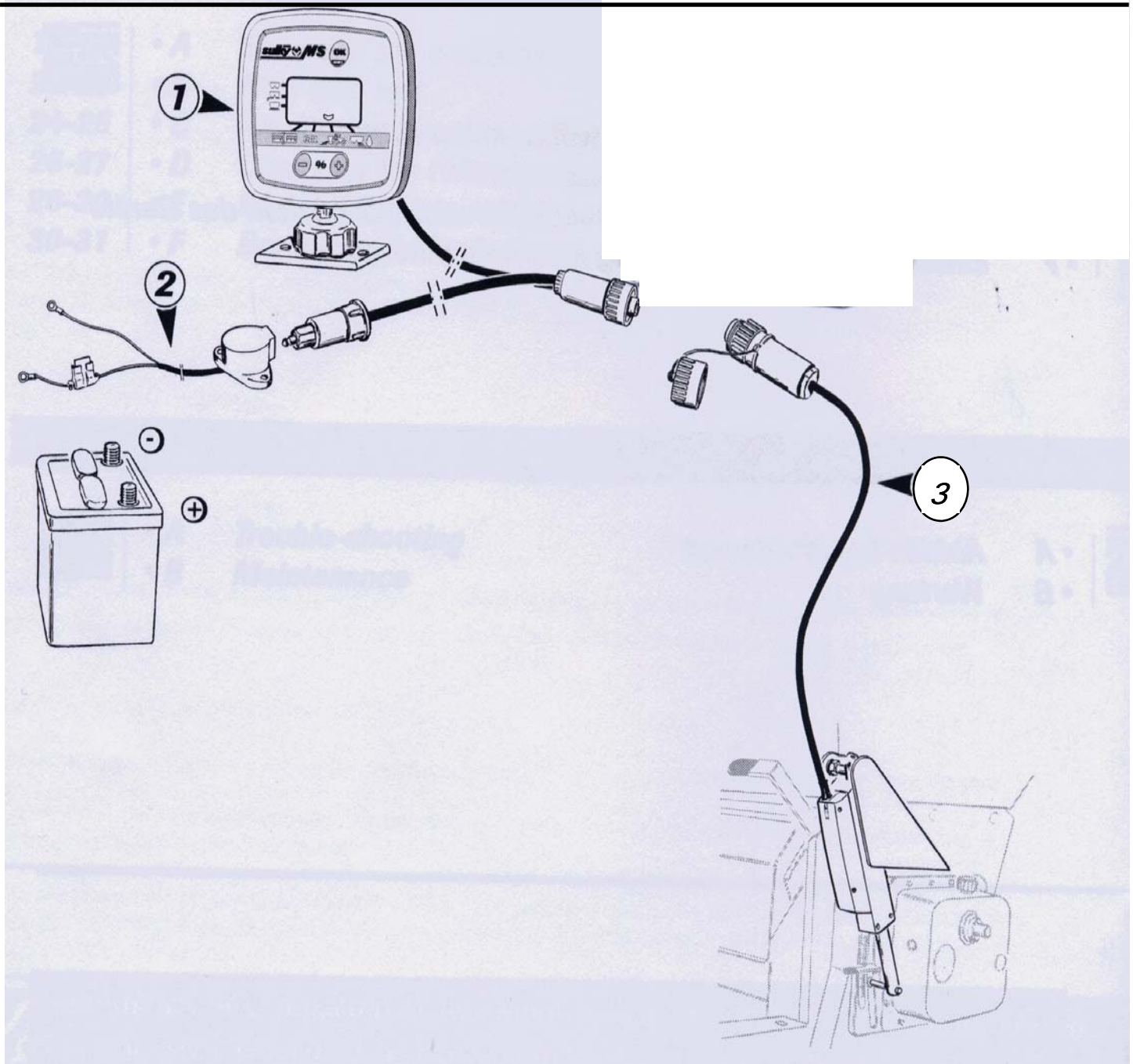

System function icons

Connection:

1. MS unit.
2. Power supply circuit with 7.5 Amp fuse.
3. Sower Ram Bundle.

Power Connection

Connection:

It is mandatory to connect the Unit directly to the 12 Volt battery with the connection cable provided. The unit should be lit up when the connection is made. The unit is fitted with a buffer battery to preserve data.

Starting up

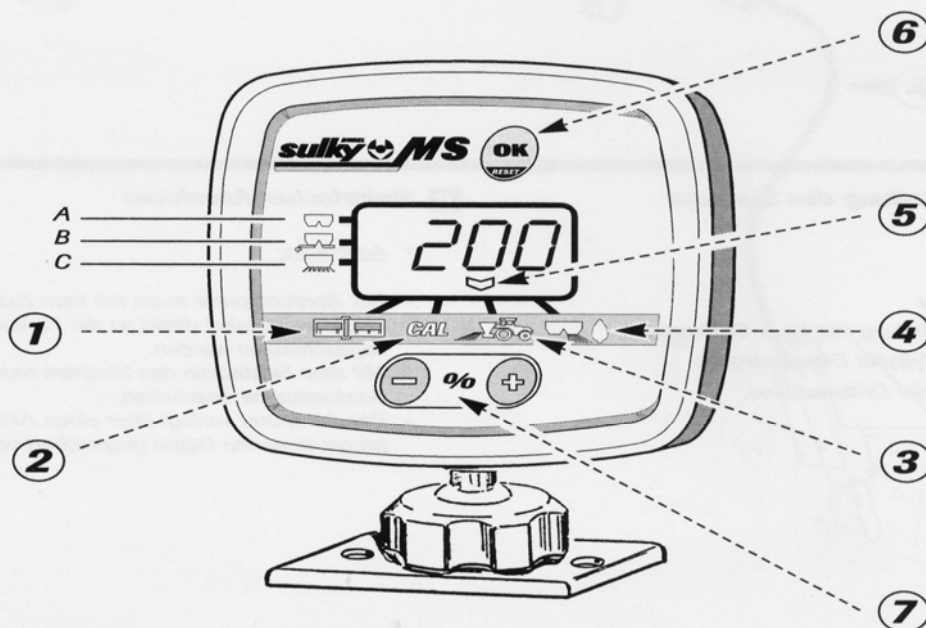
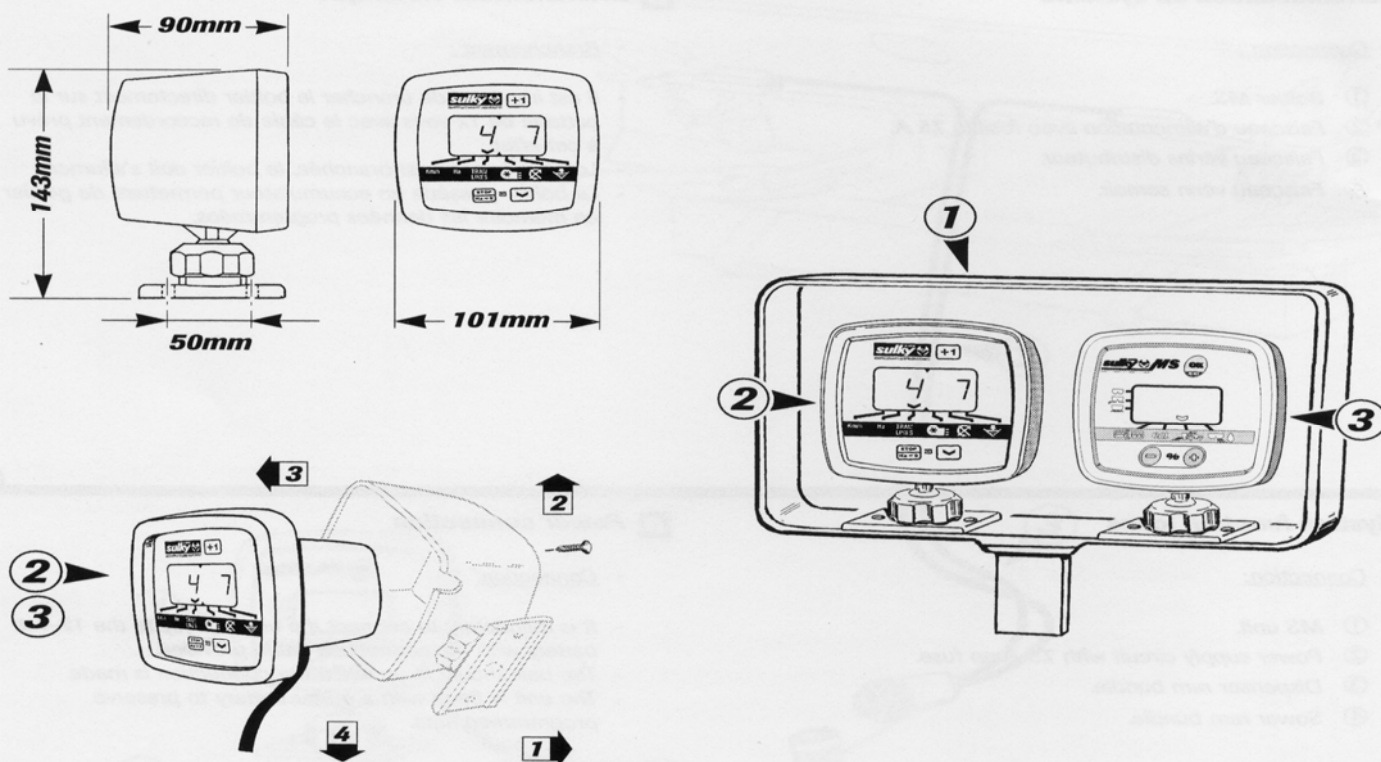

C Mounting the unit

- **Positioning:**
 - The electronic unit should be positioned in such a way as to be accessible and visible to the driver.
- **Fixing:**
 - Four fixing positions in relation to the panel are available by removing the unit casing.
 - Fix the unit bracket by drilling at the chosen spot (2 holes, distance between axes = 50 mm, Ø 5 mm)
 - With sowers fitted with a Tramlines or Tronic unit, use the special MS bracket.

D Functions

- **Choosing the machine:**
 - A - DPX - GLX
 - B - DPA-XL
 - C - Sower
- ① Opening indicator.
- ② Calibration (flow rate tests).
- ③ Adjusting flow rate while working.
- ④ Border spreading.
- ⑤ Cursor.
- ⑥ Recording.
- ⑦ Changing calibration and flow rate values.

Starting up

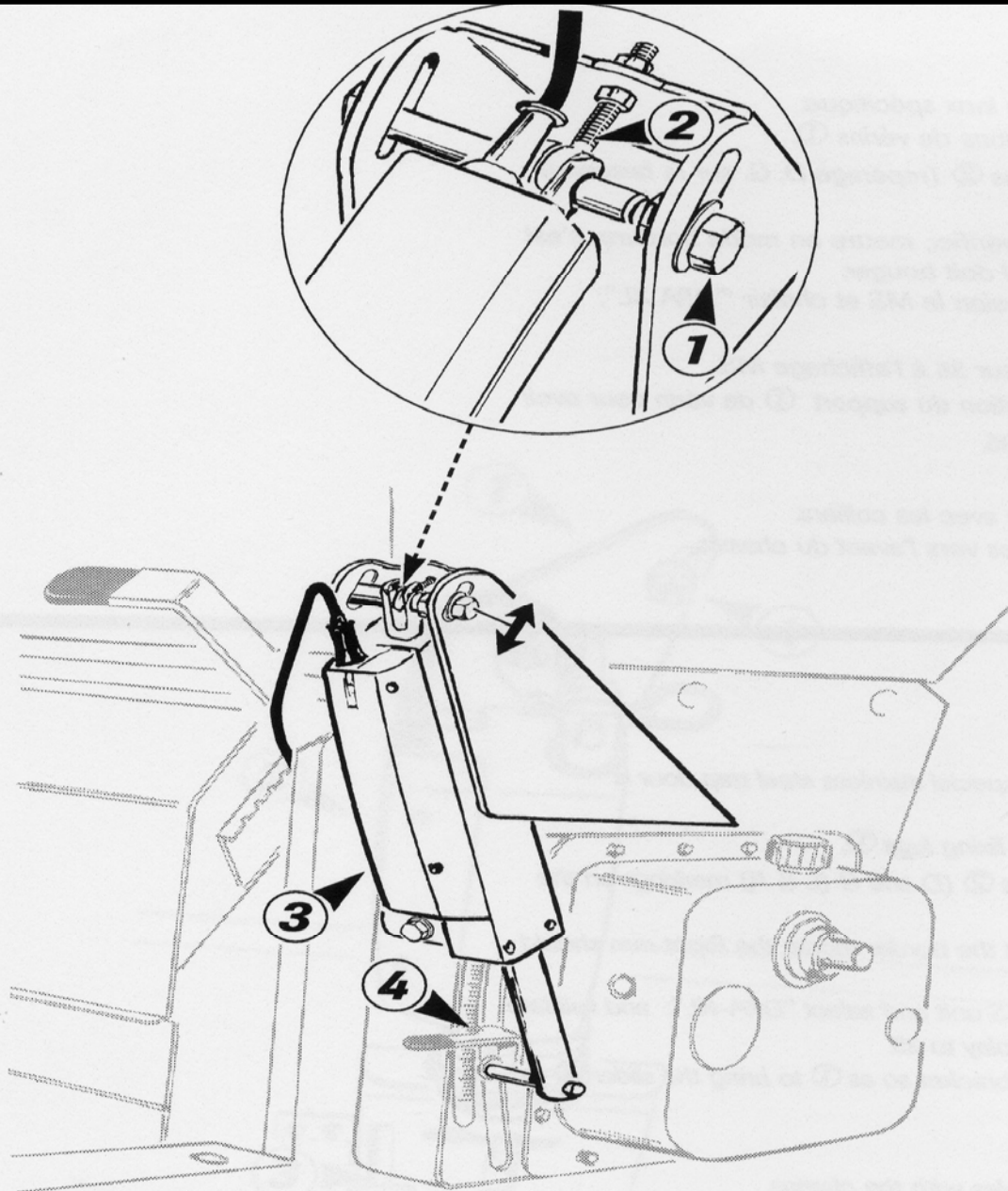

3) **SOWERS:**

- Mount the ram bracket on the upper left corner of the variator.
- Mount the ram fixing lug (Screw H10 ① + Nut + threaded adjustment rod ②), and the ram ③.
- Mount the ram ③ on the machine.
- Energize the MS unit and select "Sower"; then validate.
- Set the MS display on the 35 ④ mark.
- Move the ram bracket so that the slider comes to 35 (adjust with the threaded rod ②).
- Tighten the screw H10 ① and the nuts on the threaded adjustment rod ②.
- Secure the cables with the clamps.

Note: Without the ram bracket, there is a knurled screw for manual variator operation.

Operation

1

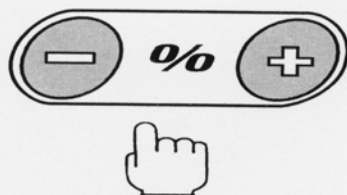

2



3



A Selecting the machine

- A ____ GLX - DPX
- B ____ DPA XL
- C ____ SOWERS

a) Selection

Turn the unit on.

1) Press

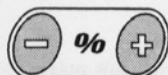

to select Sower or Dispenser (for XL see paragraph b).

2) Press



to save.

Press



again to continue.

➤ **Init** on the monitor.



Adjustment to mark **35** and cursor on 



3) Switch to **CAL** mode.

See section **B** Flow rate tests.

Note: **35** is the mean value for flow rate testing.

Operation

B

1

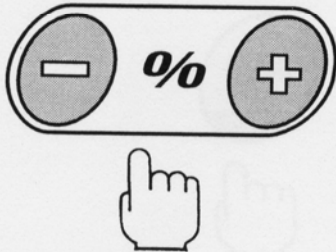

2

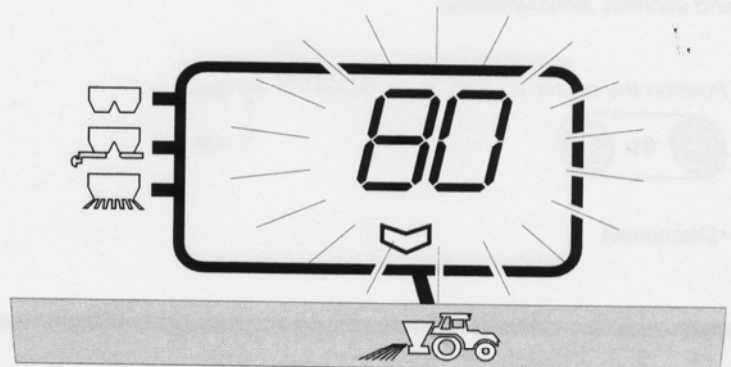

B Flow rate test

Make sure you are on **CAL** mode, **35** mark.
Perform the flow rate test (see the user's manual of the machine).

1) Weight the amount in kg (0,00).
Enter the value using

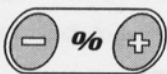

• **Note:**
for small values, entre 3 decimals.

2) Press



The unit computes and displays the dose in kg/ha.
(the dose flashes)

The cursor switches to 

Operation

B

1

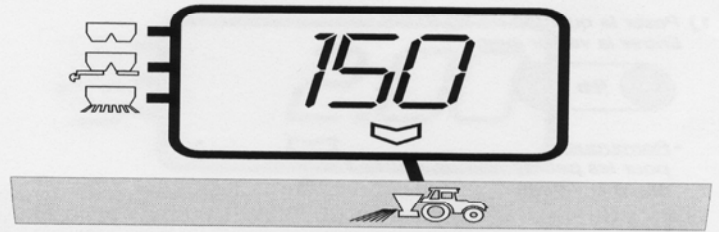

2

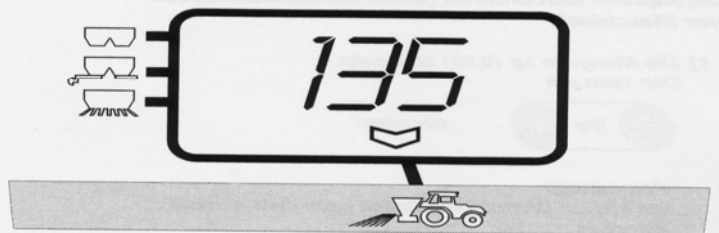
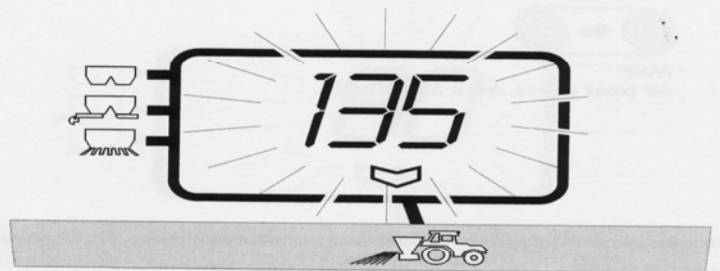
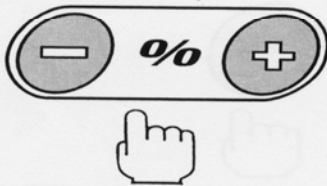

Two choices are available:

a) The dose displayed is as expected.

1) Press



You are ready to work.

b) The dose displayed differs with that expected.

1) Press

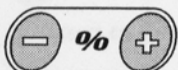

to modify the dose displayed.

2) Press



to save.

You are ready to work.

Operation

C

1

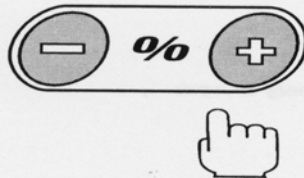
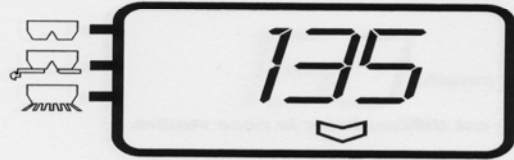
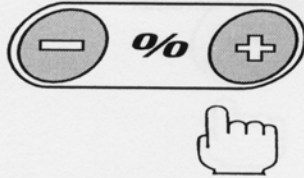

2

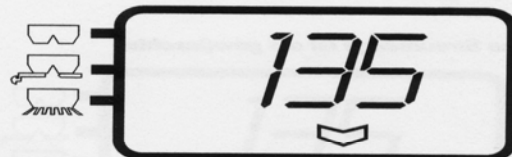

C Modulating the dose while working

1) Press

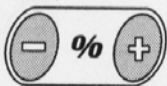

- Each pulse on the key induces a 10% increase.
- The cursor flashes.
- On the monitor, the modulated dose flashes together with the modulation percentage.

2) Press



to return to the reference dose.

Note: If the dose is set too high and the sower or dispenser cannot provide it, the amount displayed flashes.

Press



to return to the reference dose.

Operation

E

2

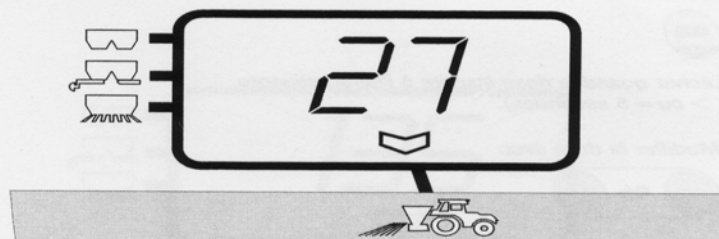

3

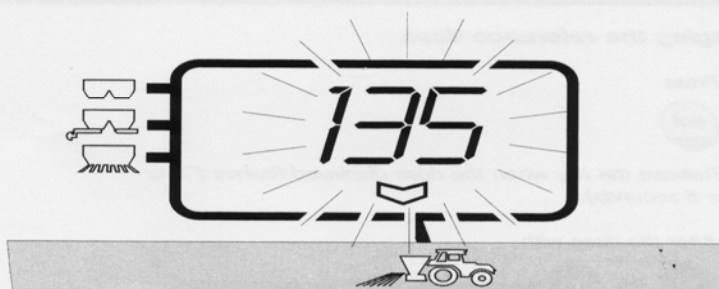
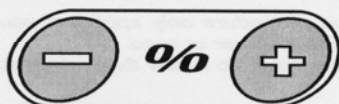

4

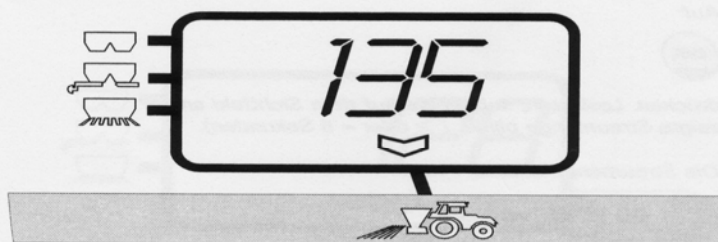

E Direct adjustment after the unit has been stopped

- The unit has memorized the latest adjustment made with the dispenser or sower.
- To proceed directly without going through the menu.

1) Start up the unit

2) Press



to validate the sower into dispenser.
The monitor displays the memorized index

3) Press



The monitor displays the dose, flashing.

4) Validate with



You are ready to work.
The reference dose will be the latest one used with the MS unit.

Optional Equipment

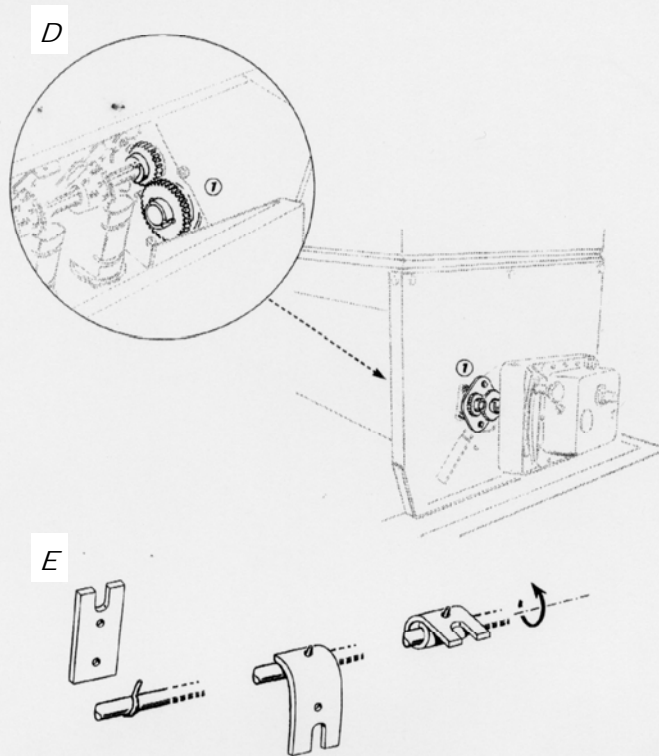

OPTIONAL EQUIPMENT

D) Variator Rotation Multiplier

- * The multiplier 1 must be used when working at speeds over 12 kph with high doses of fertiliser.

* Mounting

- Dismantle the variator.
- Remove the central coupling.
- Remove the multiplier, proceeding from outside.
- Insert the pin into the variator shaft.
- Remount the variator.

* Use

- The initial flow setting is multiplied by 2.
- Follow the indications in column B of the set-charts.

E) Flexible Agitator

- Use the flexible agitator for seeds that flow very poorly.

* Mounting

- Take the flexible rubber piece and roll it around the agitator tine as shown in the diagram.
- Note the rotation direction.

Optional Equipment

Electro Diverter Valve.

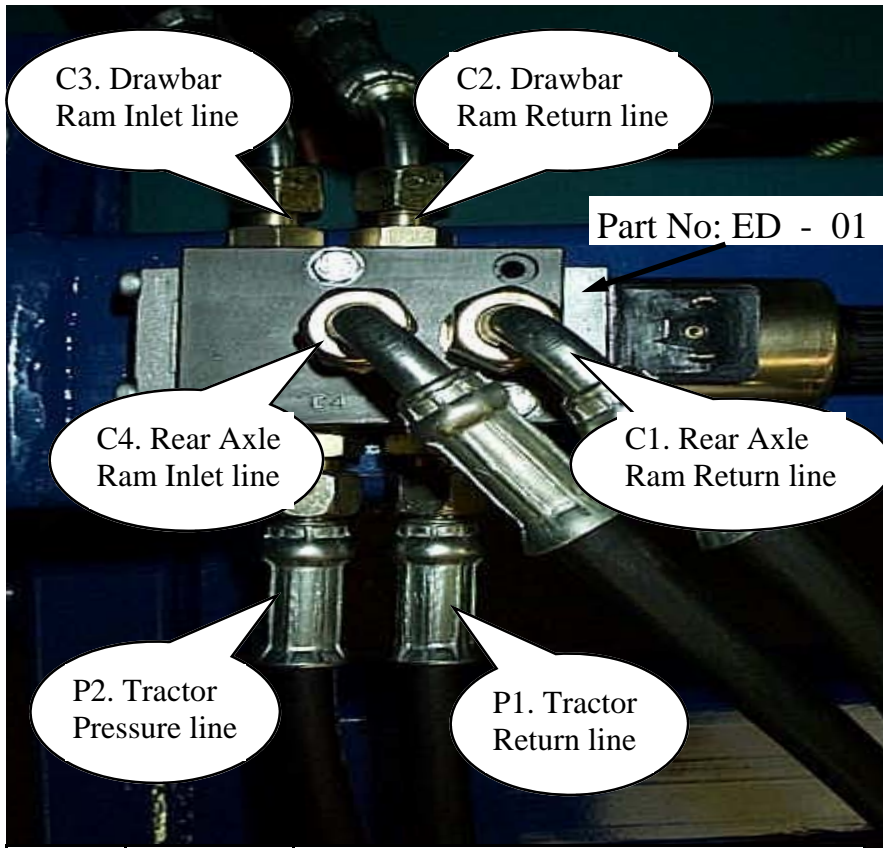

Trigger switch Joystick

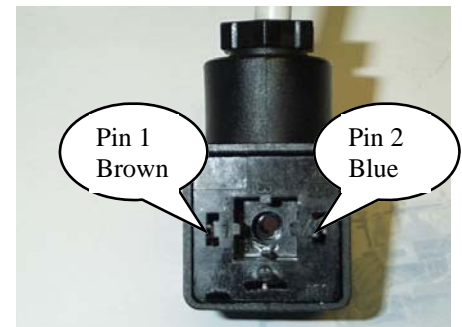

Electro Diverter Signal Herdsman

ITEM	PART No	DESCRIPTION
<i>P1</i>	HH3/4TH3/8	Tractor to Electro Diverter hose. Return Line
<i>P2</i>	HH3/4TH3/8	Tractor to Electro Diverter hose. Pressure Line
<i>C1</i>	H3/8DC3/8	Drawbar to Electro Diverter hose. Return Line
<i>C2</i>	H3/4CA3/8	Rear Axle to Electro Diverter hose. Return Line
<i>C3</i>	H3/4CA3/8	Rear Axle to Electro Diverter hose. Pressure Line
<i>C4</i>	H3/8DC3/8	Drawbar to Electro Diverter hose. Pressure Line

Electro Diverter Valve:

The Electro Diverter Valve is a valve block which controls the operation of two hydraulically operated functions. In this instance the functions are 1. Work or transport position adjustment of the rear axle, and 2. Depth adjustment of the drill via the drawbar cylinder.

Operation

Place the plug into the tractors 12 volt supply.

Attach the trigger switch Joystick to the appropriate double acting spool valve lever in the tractor cab.

The rear axle cylinders will extend / retract when the appropriate spool valve has been operated in the tractor.

When the button is pressed and held down on the joystick, and the appropriate spool valve has been operated in the tractor, the drawbar cylinder will extend / retract thus allowing depth adjustment of the drill.

Optional Equipment

Electro Diverter Valve.

Spool Valve lever mounting bracket for trigger switch joystick

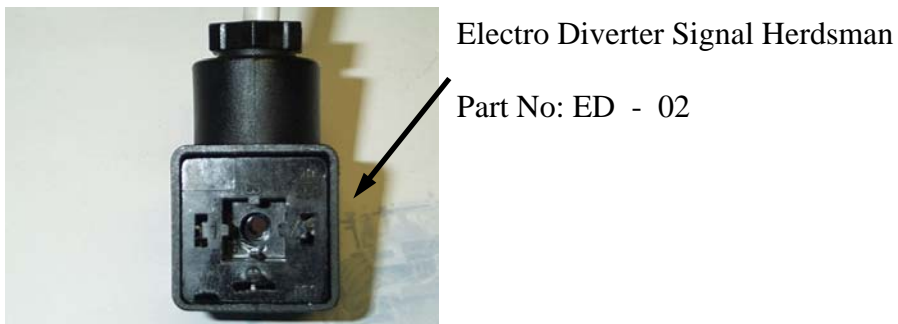
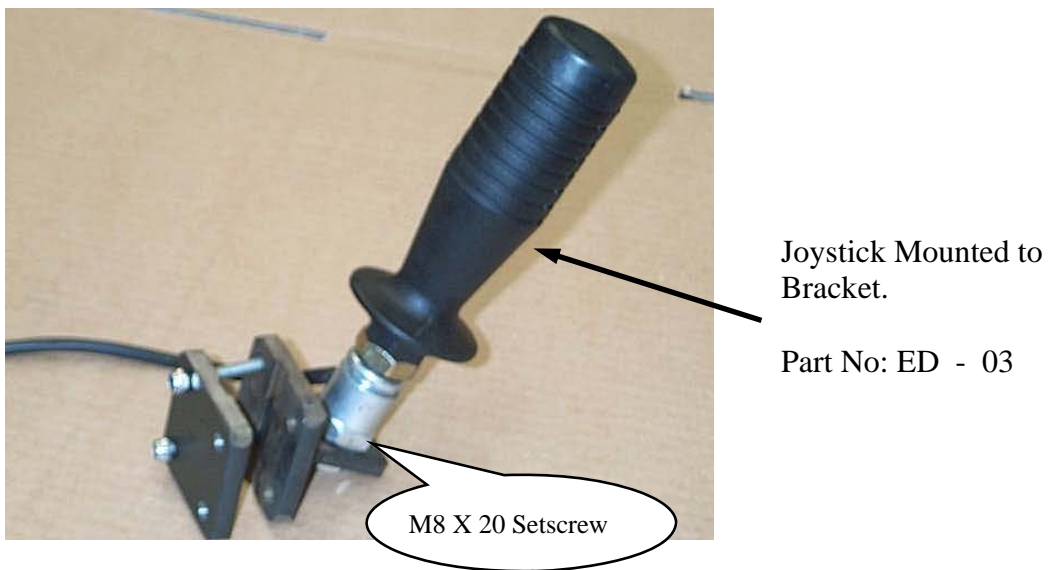
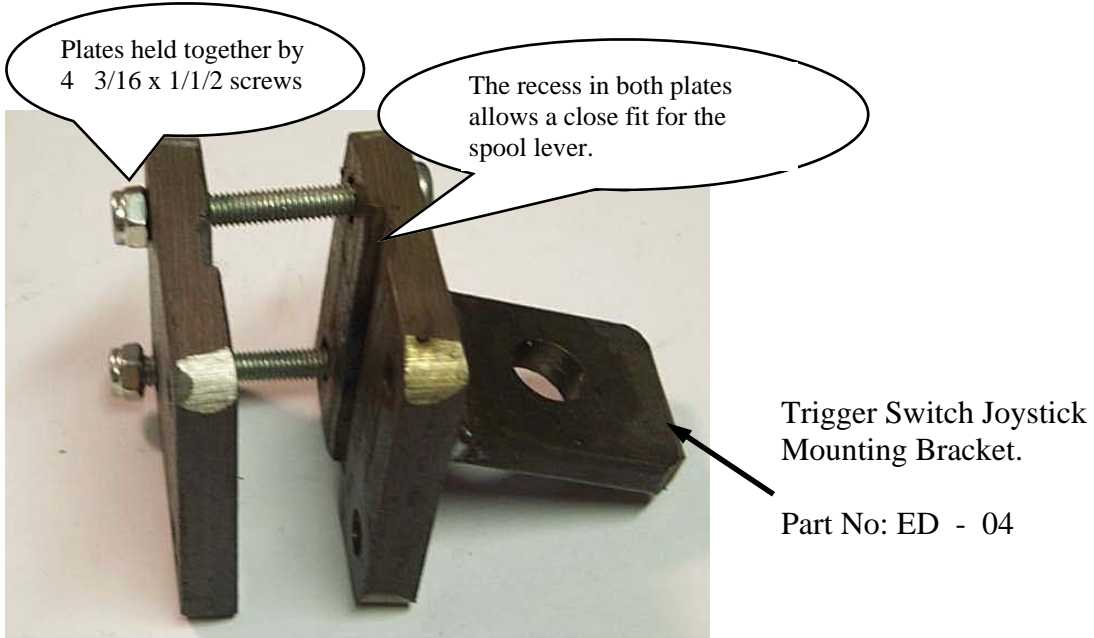

When ordering parts always have the machine serial number at hand

Notes: _____



MOORE UNIDRILL LTD
33 KIRK ROAD, BALLYMONEY, Co ANTRIM
NORTHERN IRELAND BT53 6PP

TEL: (++44) 028276 64444
FAX: (++44) 028276 65696
EMAIL: info@moore-unidrill.com
WEBSITE: www.moore-unidrill.com

Parts list

Dragarm Seeding Unit

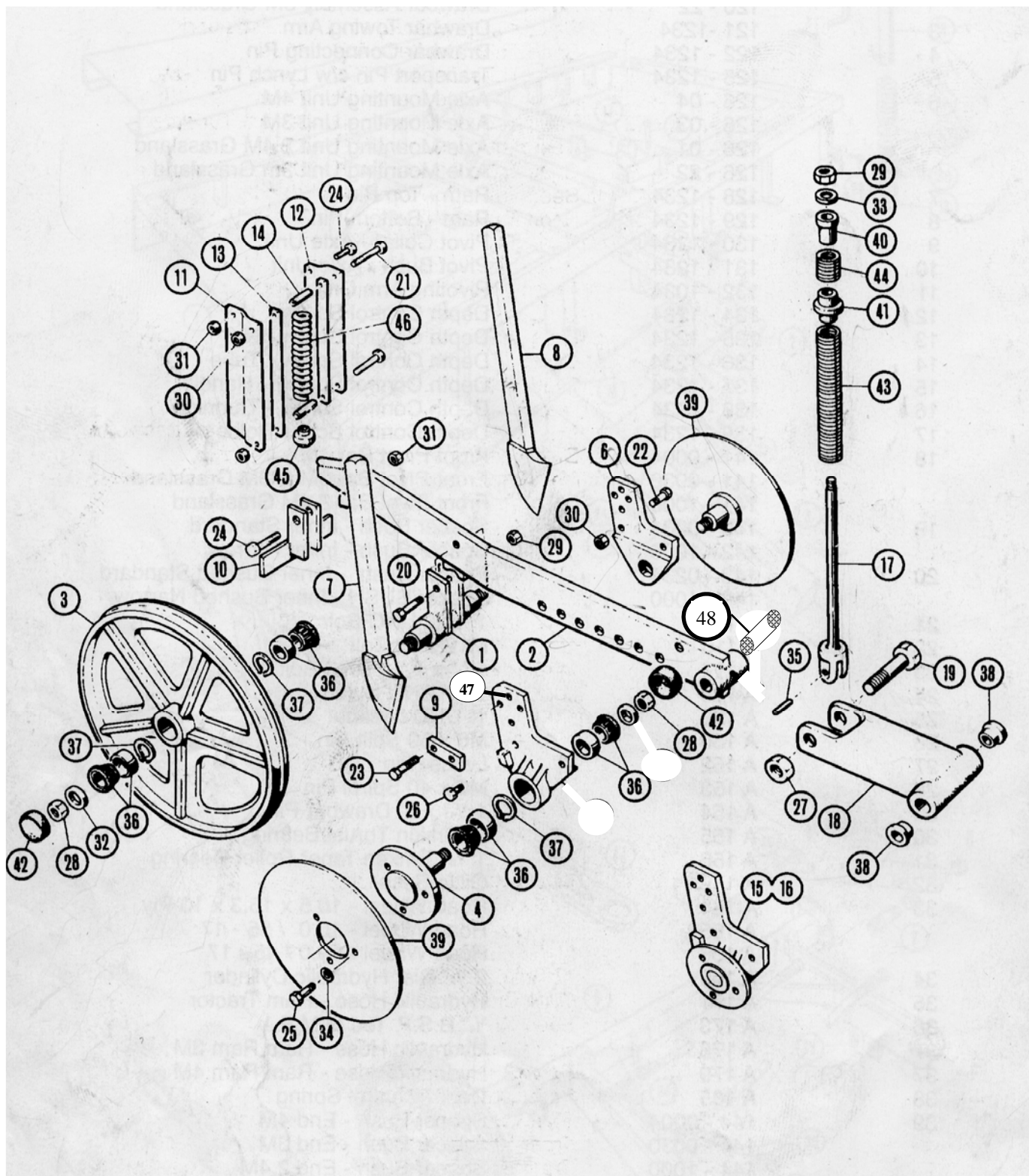

Parts list

Dragarm Seeding Unit

ITEM	PART No	DESCRIPTION	ITEM	PART No	DESCRIPTION
1	201-0234	Dragarm Axle Unit.	17	217-1234	Front Spring Arm
	201-1000N	Dragarm Axle unit Grassland Straight	18	132-1034N	Pivot Arm Unit
	201-6N	Dragarm Axle unit Grassland Stepped	19	A103N	Pivot Arm Pin
	201-40N	Dragarm Axle unit Arable Bogie	20	A107	M16 X 50 Bolt
	1.4A	Dragarm Axle unit Arable Stepped	21	A110	M12 X 75 Bolt
	201-0034	Dragarm Axle unit Arable Straight	22	A111	M12 X 55 Bolt
2	220-1A	Dragarm Mounting Bar	23	A118	M10 X 70 Bolt
3	203-1034N	Press Wheel Large.	24	A114	M10 X 50 Bolt
4	204-1234	Disc Hub	25	A119	3/8" X 3/4" Setscrew
5	205-34	Disc Mounting Bracket R.H.	26	A120	M10 X 20 Setscrew
	205-34G	Disc Mounting Bracket R.H. Grassland	27	A251	1" UNF Binx Nut
6	206-34	Disc Mounting Bracket L.H.	28	A132	3/4 UNF Locknut
	206-34G	Disc Mounting Bracket L.H. Grassland	29	A137	M16 Locknut
7	207-1234L	Seed Tube Coulter—R.H. 30mm	30	A138	M12 Locknut
	207-1234LT	Seed Tube Coulter—R.H. 30mm Tungsten	31	A139	M10 Locknut
	207-1234LTG	Seed Tube Coulter—R.H. 30mm Tungsten Grass	33	A146	M16 X 34 H.D. Washer
8	208-1234L	Seed Tube Coulter—L.H. 30mm	34	A148	3/8" Spring Washer
	208-1234LT	Seed Tube Coulter—L.H. 30mm Tungsten	35	A149	1/2" X 1 3/4" Spirol Pin
	208-1234LTG	Seed Tube Coulter—L.H. 30mm Tungsten Grass	36	A157N	1" Timken Taper Roller Bearing
9	209-1234L	Seed Tube Retaining Plate	38	A159	Oilite Bush
10	210-1000	Press Wheel Scraper Grassland	39	A160L	Seed Disc Coulter 18"
	A204	Super Scraper	40	A180	Spring Retaining Bush
	A281-1A	Super Scraper mounting bracket	41	A181	Spring Locating Bush
11	211-1234	Dragarm Guide Plate R.H.	42	A182	Dust Cap - Small
12	212-1234	Dragarm Guide Plate L.H.	43	A186	Front Spring - Lower
13	213-1234	Guide Plate Bar	44	A187	Front Spring - Upper
14	214-1234	Guide Plate Distance Piece	45	A188	Rear Spring Bush
15	1.91A	Disc Bearing Replacement Unit—R.H.	46	A189	Rear Spring. Heavy Duty
	1.911	Disc Bearing Replacement Unit—R.H. Grassland	47	A122	M10 X 25 Setscrew
16	1.81A	Disc Bearing Replacement Unit—L.H.	48	A520	Igus Bush
	1.811	Disc Bearing Replacement Unit—L.H. Grassland			

Parts list

Dragarm Axle Units

Arable Drills



Arable Drill
Stepped Axle
Unit. Part No:
1.4A



Arable Drill
Stepped axle
scraper
mounting bar.
Part No: 2.62A



Arable Drill Bogie Axle and Super
Scraper. Complete Assembly
Part No: 201 - 40N

Bogie Axle Parts

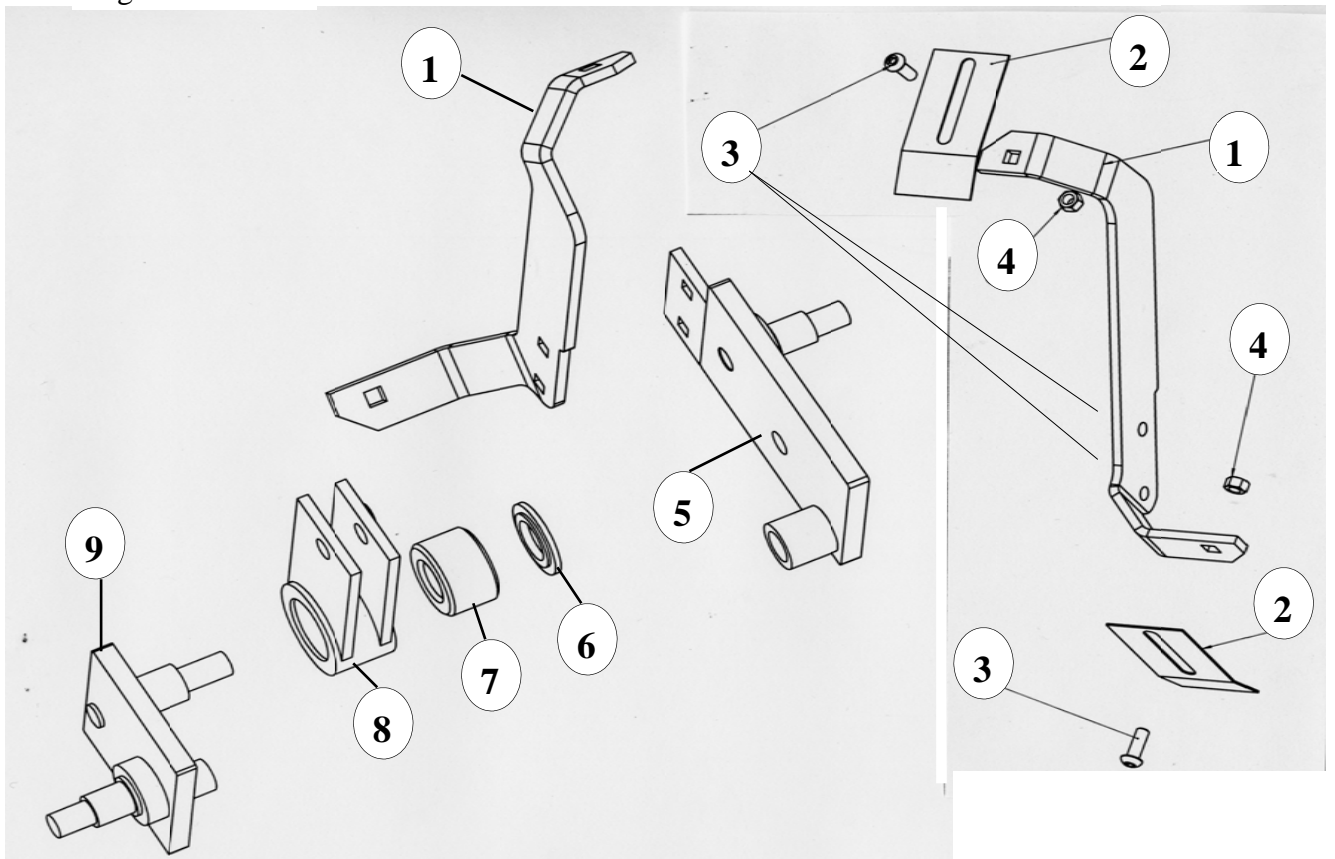

Parts list

Bogie Axle Assembly

ITEM	PART No	DESCRIPTION
1	A281-1A	Super Scraper Mounting Bracket
2	A204	Scraper
3	A127	Mounting Bracket Bolt. M12 X 30 Cup Square
	A127	Scraper Mounting Bolt M12 X 30 Cup Square
4	A138	Nut M12 Nyloc
	A138	Nut M12 Nyloc
5	1.303A	Bogie Long Arm
6	201-4E	Bogie Spacer
7	A151	Unipack Bearing 30mm
8	201-43	Bogie Mount
9	201-42N	Bogie Short Arm

Dragarm Axle Units

Grassland Drill

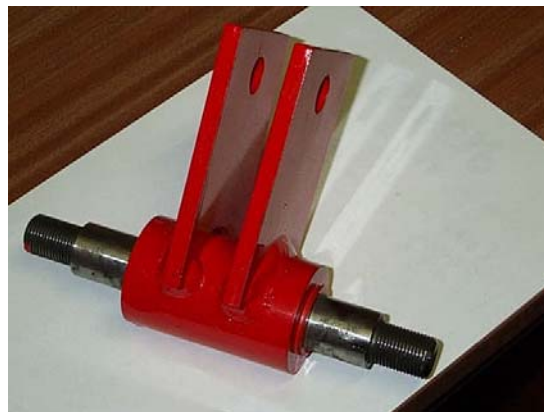

Grassland Drill Straight Axle Unit. Part No: 201 - 1000N



Grassland Drill Stepped Axle Unit. Part No: 201 - 6N

Parts list

Drawbar and Rear Axle Assembly

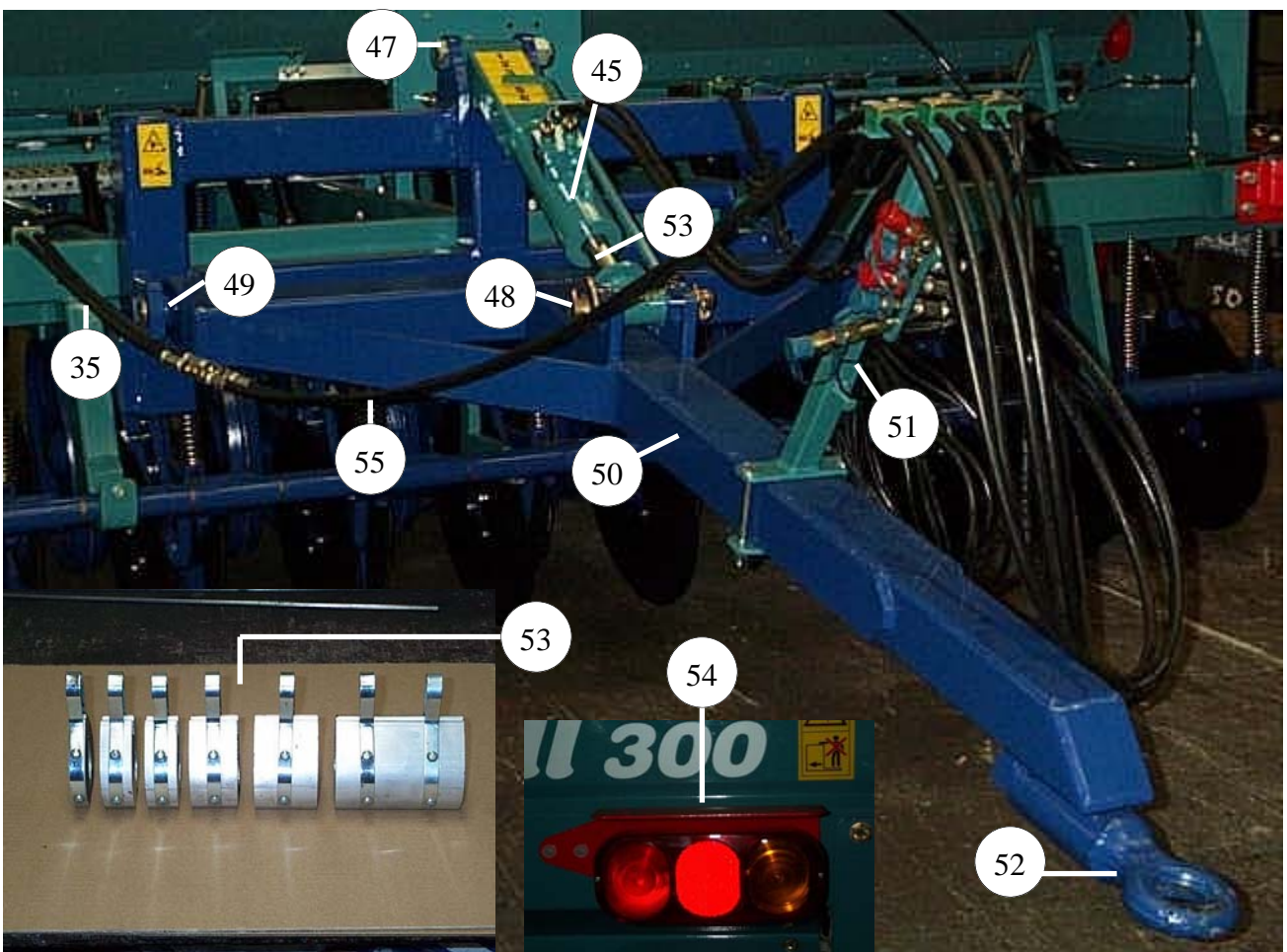
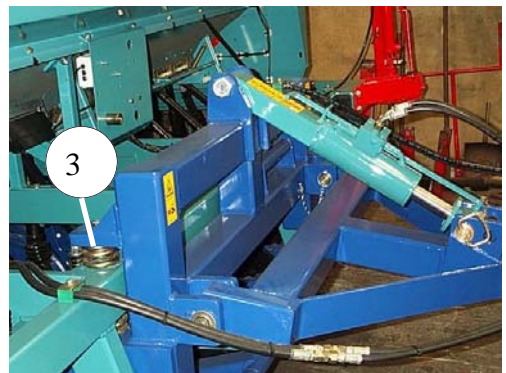
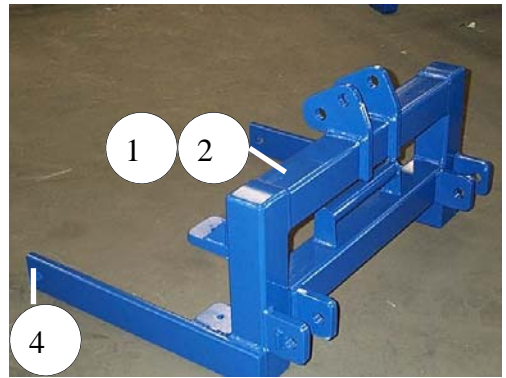
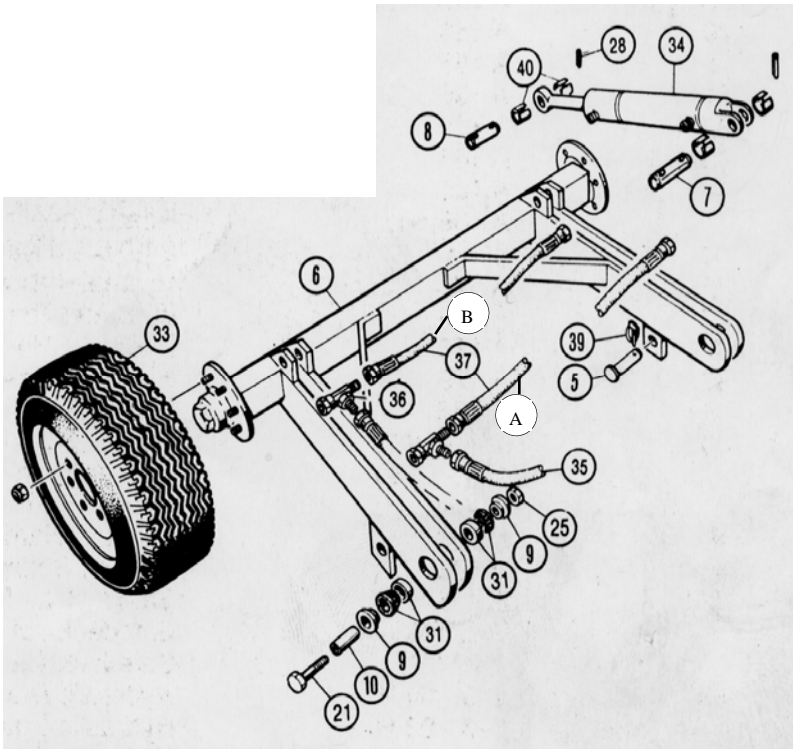

Parts list

Drawbar and Rear Axle Assembly

ITEM	PART No	DESCRIPTION	ITEM	PART No	DESCRIPTION
1	120-3A	C Frame Assembly 3M	34	BAC 358	Rear Axle Ram
	2.8AG	C Frame Assembly 3M Grassland		BAC358SK	Rear Axle Ram Seal Kit.
2	120-04	C Frame Assembly 4M	35	H3/4CAK	300 Centre Axle Hose Kit
3	A185N	C Frame Spring		H3/4CAK	400 Centre Axle Hose Kit
	120-1M	Spring Retainer	36	A173	3/8" BSP Tee Male x Male x Female
	A107	M16 X 50 Spring retainer bolt	37	H300RAK	300 Rear Axle Hydraulic Hose Kit
	A174	M16 Spring Washer		H400RAK	400 Rear Axle Hydraulic Hose Kit
4	120-8AE	C Frame Mounting Pin	40	A199	1 1/8" X 1" Hardened Bush
5	125-1C	Transport Pin C/W Lynch Pin	45	BAC303	Drawbar Ram
6	126-03	Axle Mounting Unit 3M Arable		BAC303SK	Drawbar Ram Seal Kit
	126-22	Axle Mounting Unit 3M Grassland		H3/4HDCK	Depth Control Kit
	126-04	Axle Mounting Unit 4M Arable	47		Drawbar Ram Top Bolt.
7	122-1234N	Ram to frame - Top Pin	48	A154	1 1/4" X 8" Drawbar Pin
8	129-1234	Ram - Bottom Pin	49	120-8A	Drawbar mounting pin
9	130-1234	Pivot Collar - Axle Unit	50	2.9A	Drawbar - 300 Arable
10	131-1234	Pivot Bush - Axle Unit		2.9AG	Drawbar - 300 Grassland
21	A101	1" X 6" UNC Bolt		4.9A	Drawbar - 400 Arable
25	A130	1" UNC Locknut	51	3.60A	Hydraulic Hose Stand
28	A153	M8 X 40 Spirol Pin	52	10053	Swivel Hitch
31	A156	1 3/8" Timken Taper Roller Bearing	53	A250N	Depth Segments Complete Set
33	A165NS	Road Wheel - 400/60 - 15	54	A233	Road Lighting Kit
	A166	Road Wheel - 19.0/45 - 17	55	HH3/4THK	Tractor Hose Kit

Hydraulic Parts

Ram Description	Part No	Ram Seal Kit No
Rear Axle Ram	BAC 358	BAC 358SK
Drawbar Ram	BAC 3031	BAC 3031SK

Hydraulic Pipes

Hyd. Pipe Part No	Item No	Description	No per Machine
H300RA1 3/8	37A	Rear Axle hose C300	1
H300RA2 3/8	37B	Rear Axle hose C300	1
HH400RA1 3/8	37A	Rear Axle hose C400	1
HH400RA2 3/8	38B	Rear Axle hose C400	1
H3/4HDC 3/8	45	Depth Control hose	2
HH3/4TH 3/8	55	Tractor hose	2
H3/4CA 3/8	35	Centre Axle hose	2

Depth Segments

Size	Part No	Quantity
1/2"	1/2"BSCB	1
1"	1"BSCB	2
1 1/2"	1 1/2"BSCB	1
2"	2"BSCB	1
4"	4"BSCB	1

Parts list

Drive wheel Assembly

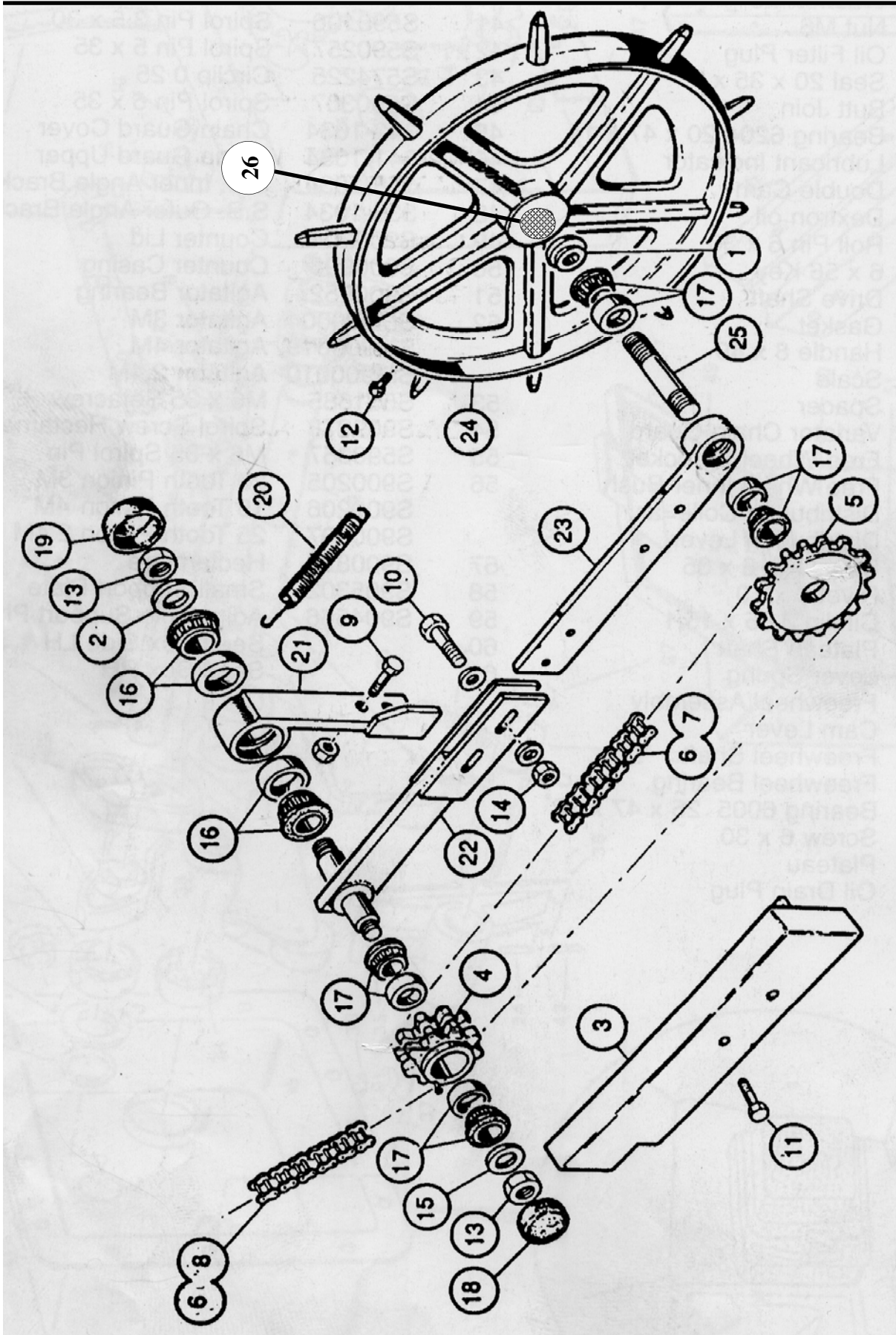

Parts list

Drive wheel Assembly

ITEM	PART No:	DESCRIPTION
<i>1</i>	318-1034	Drive Wheel Spacer
<i>2</i>	319-1234	Pivot Bracket. Washer
<i>3</i>	340-1034	Chainguard — Lower
<i>4</i>	S900594	16T Double Drive Sprocket
<i>5</i>	344-1034	20T Drive Sprocket
<i>6</i>	348-1034	Connecting Link
<i>7</i>	DC-5/8-02	Drive Chain Lower 66 Links
<i>8</i>	DC-5/8-01	Drive Chain Upper 58 Links
<i>9</i>	A106	M20 X 70 Bolt
<i>10</i>	A111	M12 X 55 Bolt
<i>11</i>	A214	M10 X 80 Bolt
<i>12</i>	A121	M10 X 40 Setscrew
<i>13</i>	A132	3/4 UNF Locknut
<i>14</i>	A138	M12 Locknut
<i>15</i>	A145	M20 X 34 Heavy Duty Washer
<i>16</i>	A156	3/8" Timken Tapered Roller Bearing
<i>17</i>	A157N	1" Timken Tapered Roller Bearing
<i>18</i>	A182	Dustcap - Small
<i>19</i>	A183	Dustcap - Large
<i>20</i>	A493	Tension Spring
<i>21</i>	3.01A	Support Arm - Pivot Bracket
<i>22</i>	314-1234	Drive Wheel Support Arm - Upper
<i>23</i>	315-1234	Drive Wheel Support Arm - Lower
<i>24</i>	316-1234	Drive Wheel
<i>25</i>	317-1234	Drive Wheel Axle

Parts list

Seed Box Assembly

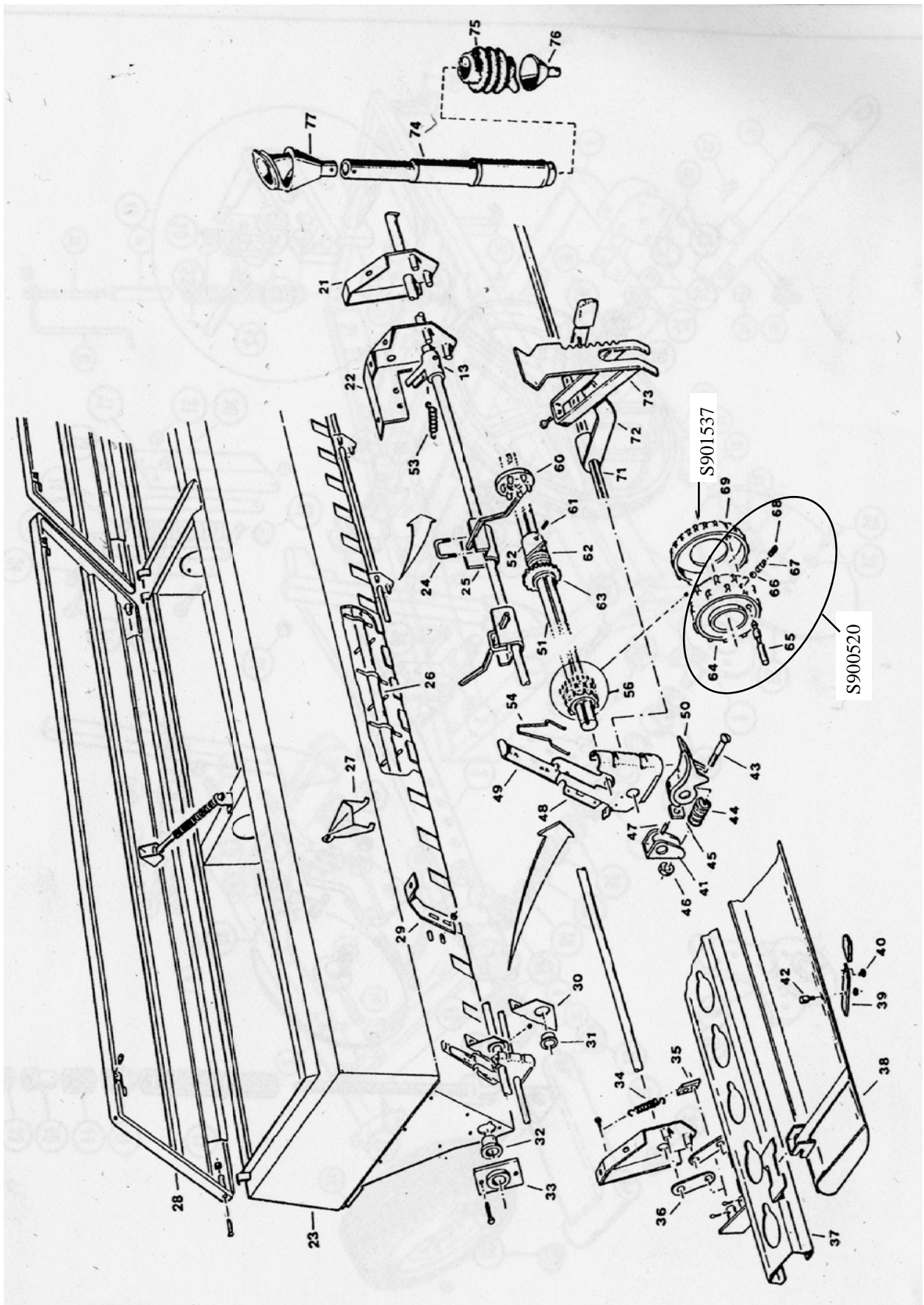

Parts list

Seed Box Assembly

ITEM	PART No:	DESCRIPTION	ITEM	PART No:	DESCRIPTION
21	S900052	Spring Holding Plate	46	S571458	M8 Locknut
22	S900045	Ram Holding Plate	47	S540855	M8 X 15 Screw
23	A207A	Seed Box 4m	48	S900489	Seed Feeding Unit
	A206A	Seed Box 3m	49	S907381	Feed Trap Shutter
24	S901578	U Bolt Clamp	50	S985209	Skid Flap
25	S906168	Tramline U-Plate	51	SM901446	Seed Feed Drive Shaft 4M
26	SM900019	Seed Agitator 4M		SM901447	Seed Feed Drive Shaft 3M
	SM900004	Seed Agitator 3M	52	S901543	Clutch Hub
27	S907671	Plastic Partition	53	S909095	Retention Spring
28	SM909733	Seed Box Lid 4M	54	S909068	Feed Trap Spring
	SM909734	Seed Box Lid 3M	56	S900520	Seed Wheel Unit
29	S906154	Tray Clip Clutch	60	S900043	Tramline Lever
30	S901473	Shaft Bearing Plate	61	S554610	M6 X 20 Screw
31	S901547	Plastic Bearing	62	S909083	Clutch Spring
32	S901546	Seed Box End Bearing	63	S901538	Fine Seed Clutch Wheel
33	S900952	Agitator Bearing Plate	64	S901539	Standard Seed Wheel
34	S908010	Retention Spring	65	S901542	Seed Wheel Lock Pin
35	S904319	Spring Fastener	66	S580104	Steel Ball
36	S904757	Nylon Pivot Arm	67	S909082	Spring
37	SM900210	Seedcup Holder Unit 4M	68	S901541	Plastic Screw
	SM900207	Seedcup Holder Unit 3M	69	S901537	Fine Seed Wheel
38	SM900969	Cover/Collection Tray 4M	71	SM901448	Skid Adjustment Shaft 4M
	SM900967	Cover/Collection Tray 3M		SM901449	Skid Adjustment Shaft 3M
39	S909076	Tray Spring Clip	72	S900975	Skid Adjustment Handle
40	S555660	M6 X 10 Setscrew	73	SM900976	Central Adjustment Bracket
41	S904599	Skid Flap Support	74	A315	Flexible Seed Tube 3 Piece
42	S908278	Tray Pin	75	A325	Seed Tube Bellows
43	S525895	M8 X 45 Screw	76	A326	Seed Tube Joint 25mm
44	S909081	Skid Flap Spring		A326L	Seed Tube Joint 30mm
45	S571806	M8 Square Nut	77	A330	Seed Cup Holder

Parts list

Seed Box Drive Unit

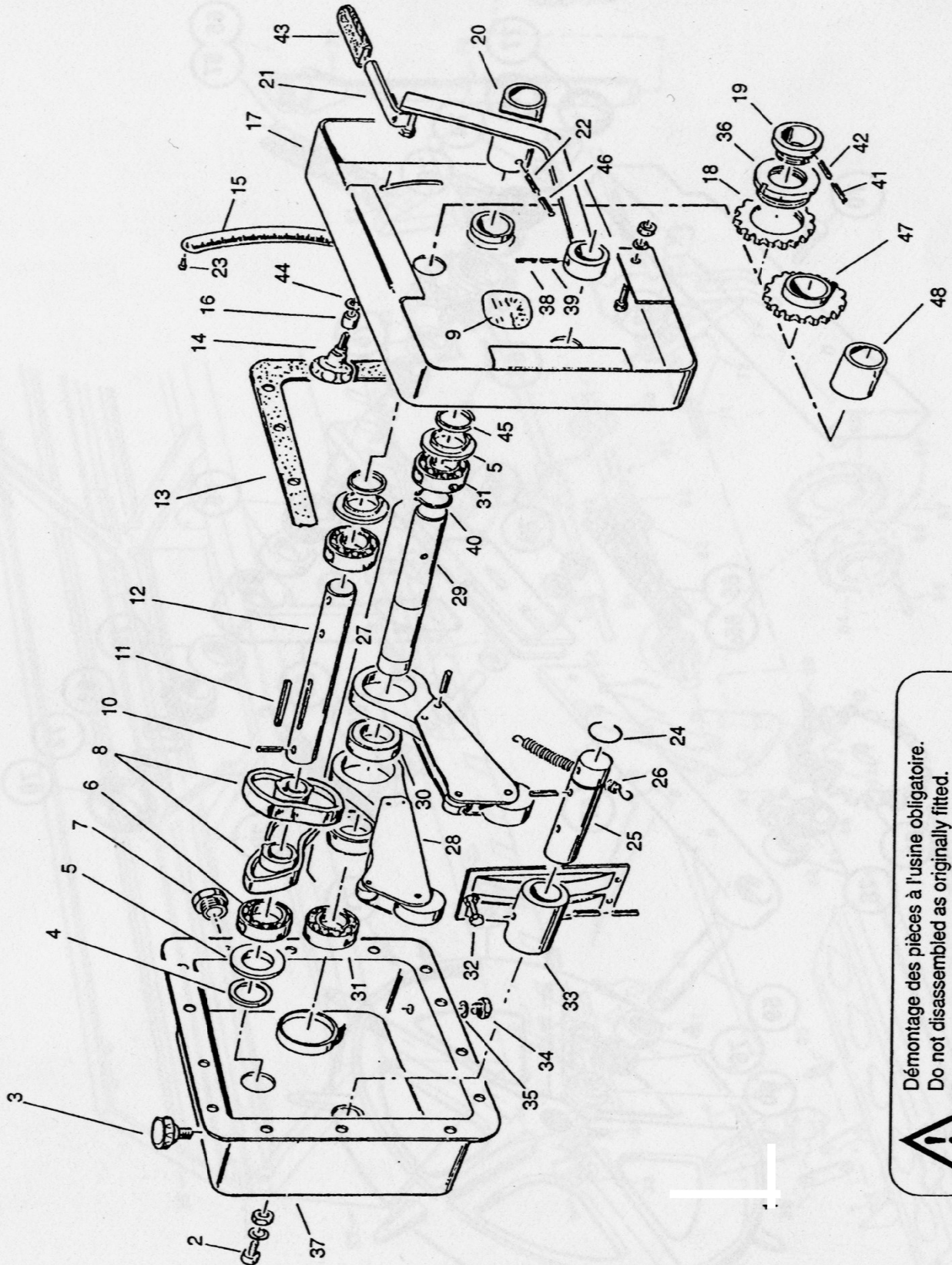

 Démontage des pièces à l'usine obligatoire.
Do not disassemble as originally fitted.
Die werkseitig eingebauten teile nicht abmontieren.

Parts list

Seed Box Drive Unit

ITEM	PART No	DESCRIPTION	ITEM	PART No	DESCRIPTION
1	S910221	Variator 2	24	S732001	Circlip 2.65 X 15.1
2	S553612	Allen Screw 6 X 12	25	S922029	Plateau Shaft
	S573107	Washer M6	26	S981008	Lever Spring
	S571206	Nut M6	27	S910239	Freewheel Assembly
3	S795060	Oil Filter Plug	28	S914022	Cam Lever
4	S751005	Seal 20 X 35 7	29	S922031	Freewheel Shaft
5	S963080	Butt Join	30	S712013	Freewheel Bearing
6	S711010	Bearing 6204 20 X 47 X 14	31	S711009	Bearing 6005 25 X 47 X 12
7	S795070	Lubricant Indicator	32	S551684	Screw 6 X 30
8	S935002	Double Cam	33	S915013	Plateau
9	S480002	Dextron 1 Litre	34	S984008	Oil Drain Plug
10	S590306	Roll Pin 6 X 30	35	S737003	Oil Drain Seal
11	S596875	6 X 56 Key	36	S712014	Freewheel Collar
12	S922033	Drive Shaft	37	S914025	Variator Cover
13	S987703	Gasket	38	S590106	Spirol Pin 3.5 X 30
14	S910296	Handle 8 X 40	39	S590307	Spirol Pin 6 x 35
15	S989002	Scale	40	S574225	Circlip Dia 25
16	S925027	Spacer	41	S590306	Spirol Pin 6 x 30
17	S918096	Variator Chain Guard	42	S590106	Spirol Pin 3.5 X 30
18	S901040	Freewheel Sprocket	43	S415749	Lever Tip 14 X 4 X 50
19	S923043	Freewheel Inner Bush	44	S573260	Washer M8
20	S915014	Distribution Collar	45	S751005	Seal 20 X 35 7
21	S915012	Distribution Lever	46	S590257	Spirol Pin 5 X 35
22	S89407	Spirol Pin 8 X 35	47	S980753	Pinion
23	S598041	Rivet 4 X 10	48	S925042	Pinion Insert

Parts list

Multiplicator

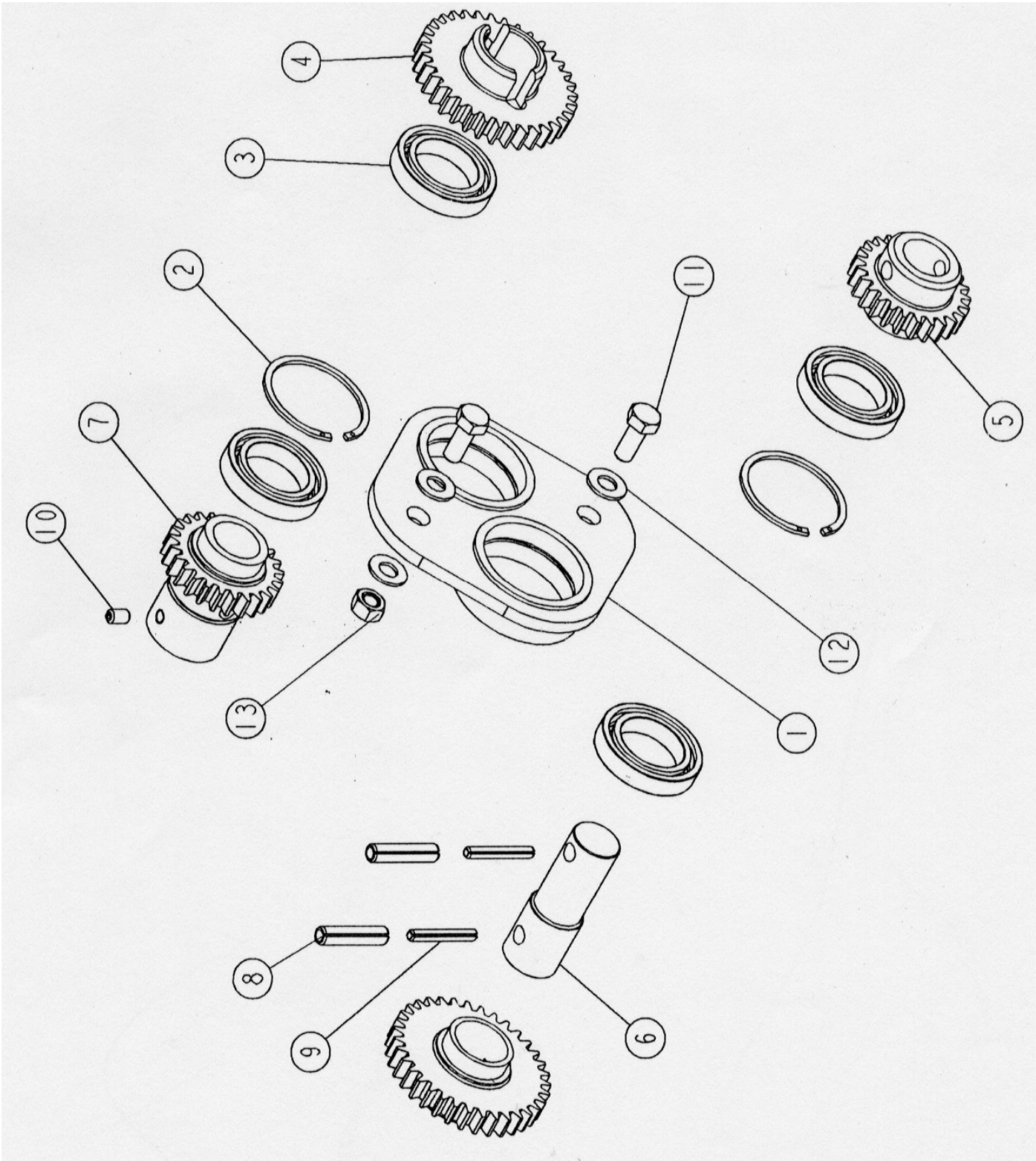

Parts list

Multiplicator

ITEM	PART No	DESCRIPTION
<i>1</i>	S914114	Multiplicator Bracket
<i>2</i>	S574225	Circlip
<i>3</i>	S711015	Bearing 30 x 47 x 9
<i>4</i>	S980781	Sprocket 35 Tooth
<i>5</i>	S980780	Sprocket 25 Tooth
<i>6</i>	S930024	Sprocket Bar
<i>7</i>	S915041	Multi Sprocket 25 Tooth
<i>8</i>	S590407	Roll Pin M8 x 35
<i>9</i>	S590207	Roll Pin M5 x 35
<i>10</i>	S554610	M6 x 10 Grub Screw
<i>11</i>	S551780	M8 x 20 Bolt
<i>12</i>	S573158	M8 Washer
<i>13</i>	S571208	M8 Nut

Parts list

MS Flow Modulation

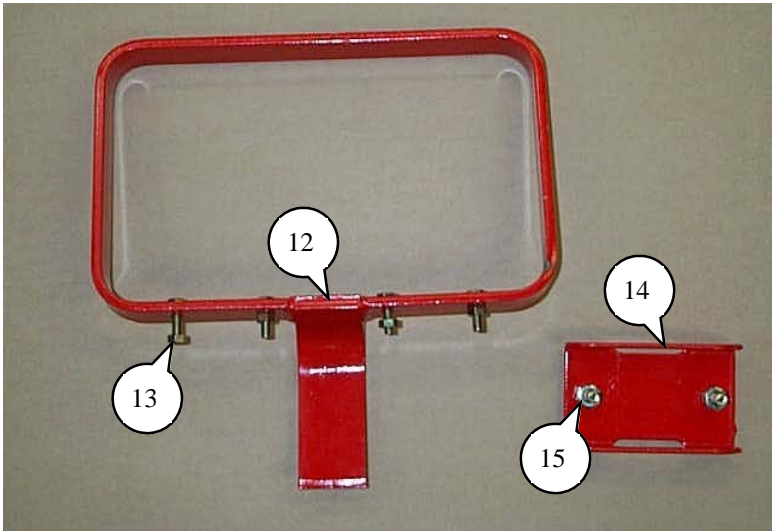
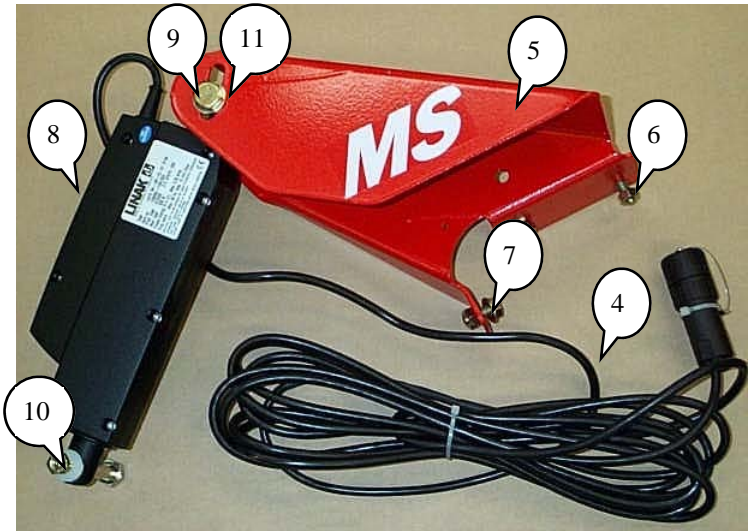
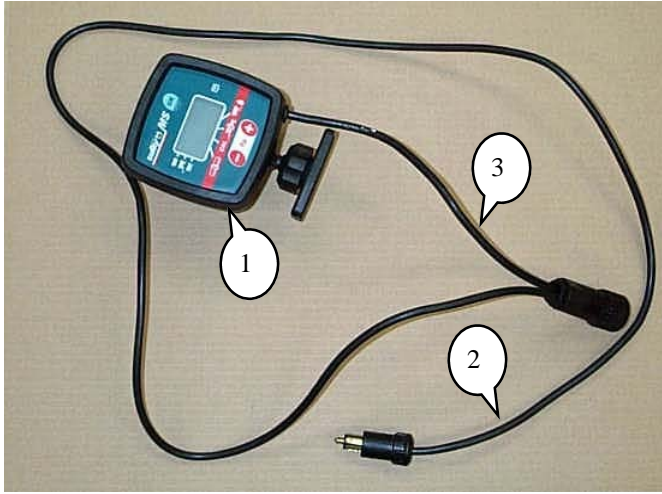

Parts list

MS Flow Modulation

Item Number	Part Number	Description
<i>1</i>	MS - 01	MS control pod
<i>2</i>	MS - 02	MS control pod power lead
<i>3</i>	MS - 03	Lead from MS pod to sensor
<i>4</i>	MS - 04	Lead from linak actuator to sensor
<i>5</i>	MS - 05	Linak actuator mounting bracket
<i>6</i>	MS - 06	Mounting bracket setscrews. M8 x 20
<i>7</i>	MS - 07	M8 Washer
<i>8</i>	MS - 08	Linak actuator
<i>9</i>	MS - 09	Linak actuator top bolt. M10 x 100
<i>10</i>	MS - 10	Linak actuator bottom bolt. M10 x 100
<i>11</i>	MS - 11	M10 Washer
<i>12</i>	MS - 12	MS pod mounting bracket
<i>13</i>	MS - 13	Ms pod mounting bracket setscrews. M6 x 20
<i>14</i>	MS - 14	Mounting bracket clamp
<i>15</i>	MS - 15	Mounting bracket clamp setscrews. M8 x 35

Parts list

Linak Actuator - Tramline Mechanism



Parts list

Linak Actuator - Tramline Mechanism

Item Number	Part Number	Description
<i>1</i>	A201	Linak Actuator
<i>2</i>	LA - 02	Linak Actuator cable
<i>3</i>	LA - 03	Linak Arm Support
<i>4</i>	A219	Arm support mounting bolts. M8 x 20
	A140	M8 Nyloc nut.
<i>5</i>	A218	Linak Actuator / Arm support bolt. M8 x 35
	A140	M8 Nyloc nut
<i>6</i>	A218	Linak Actuator / Adjustable stop bolt. M8 x 35
	A140	M8 Nyloc nut
<i>7</i>	S555660	M6 x 10 Setscrew
<i>8</i>	S573107	M6 Washer
<i>9</i>	LA - 09	Adjustable stop setscrew holder.

Parts list

Seedbox Metering Parts

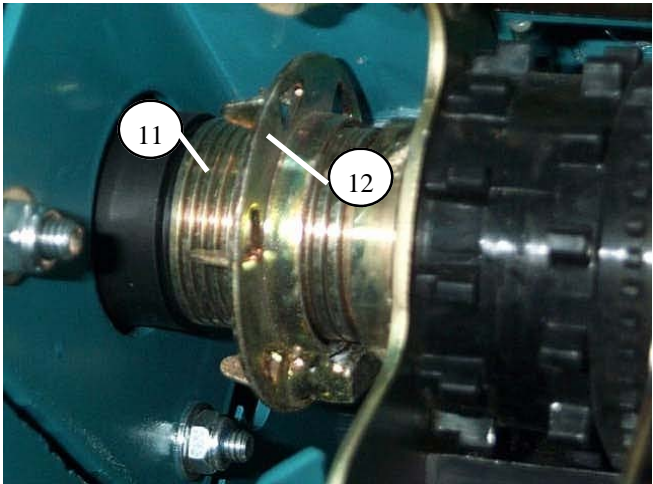
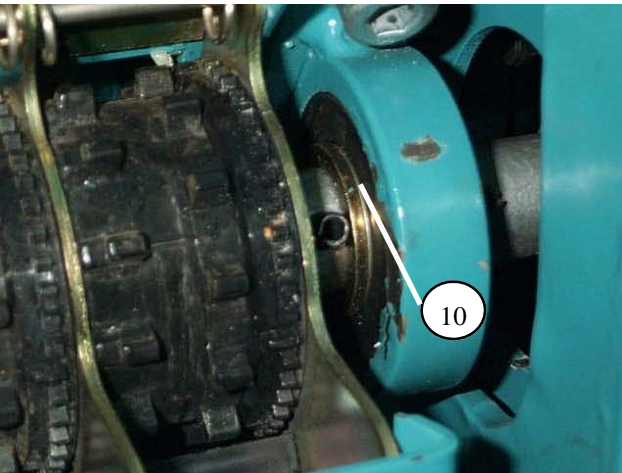
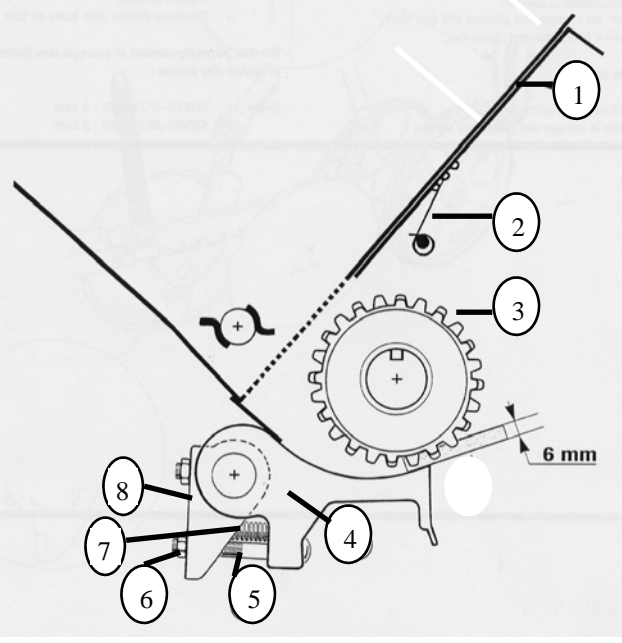

Parts list

Seedbox Metering Parts

ITEM	PART No	DESCRIPTION
<i>1</i>	S907381	Feed Trap Shutter
<i>2</i>	S909068	Feed Trap Spring
<i>3</i>	S901539	Standard Seed Wheel
	S901538	Fine Seed Wheel
<i>4</i>	S985209	Skid Flap
<i>5</i>	S525895	M8 X 45 Screw
<i>6</i>	S571806	M8 Nut
<i>7</i>	S909081	Skid Flap Spring
<i>8</i>	S904599	Skid Flap Support
<i>9</i>	S985210	Rape Shutter
<i>10</i>	S711008	Distribution Shaft Bearing
<i>11</i>	S909083	Clutch Spring
<i>12</i>	S923067	Clutch Spring Retainer

Parts list

SPI Vertical Lift Marker

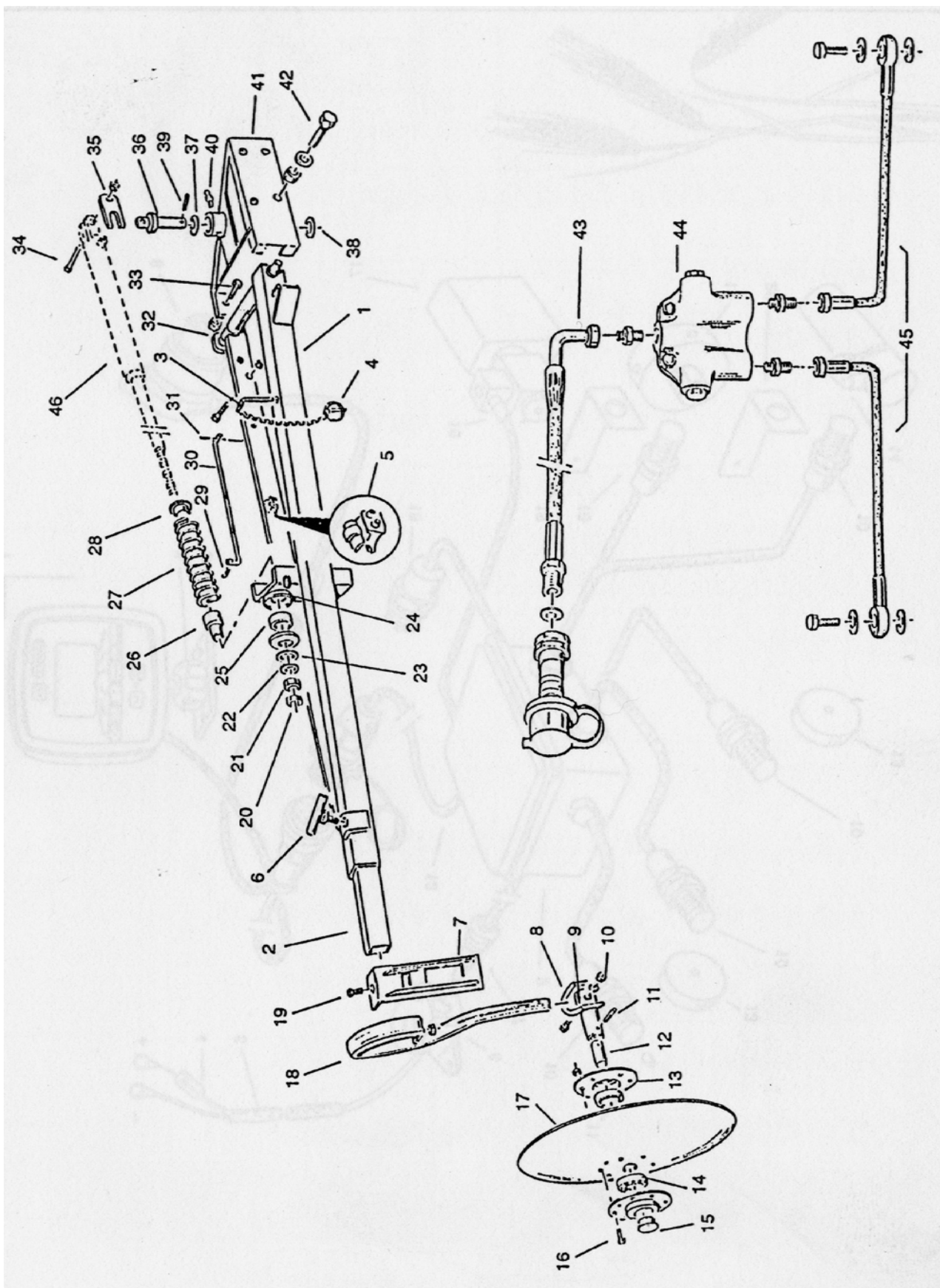

Parts list

SPI Vertical Lift Marker

ITEM	PART No	DESCRIPTION	ITEM	PART No	DESCRIPTION
<i>1</i>	S917109	Marker Arm Outer	<i>25</i>	S981801	Nylon Bush
<i>2</i>	S940032	Marker Arm Inner	<i>26</i>	S964064	Nylon Ram Locator
<i>3</i>	S927002	Marker Arm Pin	<i>27</i>	S981302	Spring
<i>4</i>	S594606	Lynch Pin	<i>28</i>	S985009	Spring Locator
<i>5</i>	S415752	Stay Clip	<i>29</i>	S592202	R Clip
<i>6</i>	S918093	Length Adjusting Handle	<i>30</i>	S962074	Marker Stay - Left
<i>7</i>	S916049	S Tine Support		S962072	Marker Stay - Right
<i>8</i>	S914011	Marker Angle adjustment Bracket	<i>31</i>	S589207	Roll Pin M5 X 35
<i>9</i>	S963025	Angle Adjustment Block	<i>32</i>	S914071	Marker Pivot Shaft
<i>10</i>	S552115	Bolt M10 X 60	<i>33</i>	S551890	Shear Bolt M8 X 35
	S573110	Washer M10		S571208	Shear Nut M8
	S571460	Nut M10	<i>34</i>	S552720	Ram Pivot Bolt M16 X 70
<i>11</i>	S590307	Roll Pin M6 X 35		S571216	Ram Pivot Nut M16
<i>12</i>	S921017	Marker Disc Shaft	<i>35</i>	S962071	Locking Plate
<i>13</i>	S908360	Bearing Holder	<i>36</i>	S920019	Lateral Pivot
<i>14</i>	S711000	Marker Bearing	<i>37</i>	S732005	Washer
<i>15</i>	S415717	Marker Bearing End Cap	<i>38</i>	S573174	Washer M25 X 50
<i>16</i>	S551662	Bolt M6 X 15	<i>39</i>	S590407	Spirol Pin M8 X 35
	S571270	Nut M6	<i>40</i>	S719001	Grease Nipple M8
<i>17</i>	S980102	Marker Disc	<i>41</i>	S910395B	Marker Mounting Bracket Left
<i>18</i>	S980003	S Tine	<i>41B</i>	S910395	Marker Mounting Bracket Right
<i>19</i>	S552125	Bolt M10 X 70	<i>42</i>	S552731	Mounting Bracket Bolt M16 x 50
	S571460	Nut M10		S573166	Mounting Bracket Washer M16
<i>20</i>	S571366	Nut M16 X 7		S571416	Mounting Bracket Nut M16
	S571216	Nut M16 X 15	<i>43</i>	S683013	Hydraulic Hose Tractor/ Shuttle Valve
<i>21</i>	S571216	Nut M16 X 15	<i>44</i>	S683009	Shuttle Valve
<i>22</i>	S573166	Washer M16	<i>45</i>	S683009	Hydraulic Hose Shuttle Valve/Markers
<i>23</i>	S573170	Washer M20	<i>46</i>	S982301	Marker Ram
<i>24</i>	S573905	Nylon Bush Locator			

Parts list

Moore Vertical Lift Marker

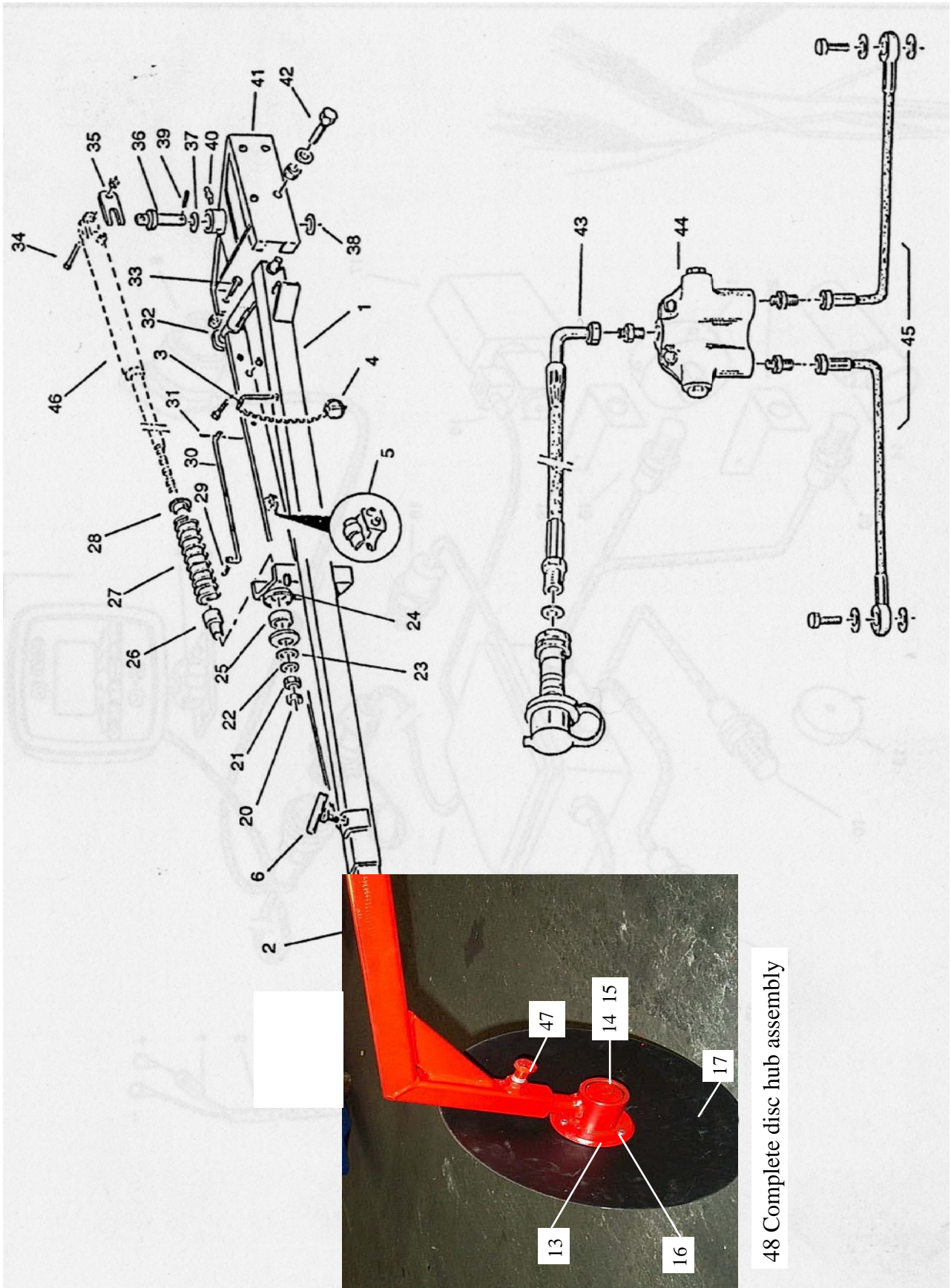

48 Complete disc hub assembly

Parts list

Moore Vertical Lift Marker

ITEM	PART No	DESCRIPTION	ITEM	PART No	DESCRIPTION
<i>1</i>	S917109	Marker Arm Outer	<i>31</i>	S589207	Roll Pin M5 X 35
<i>2</i>	145-300A	Marker Arm Inner	<i>32</i>	S914071	Marker Pivot Shaft
<i>3</i>	S927002	Marker Arm Pin	<i>33</i>	S551890	Shear Bolt M8 X 35
<i>4</i>	S594606	Lynch Pin		S571208	Shear Nut M8
<i>5</i>	S415752	Stay Clip	<i>34</i>	S552720	Ram Pivot Bolt M16 X 70
<i>6</i>	S918093	Length Adjusting Handle		S571216	Ram Pivot Nut M16
<i>13</i>	204-1234	Disc hub	<i>35</i>	S962071	Locking Plate
<i>14</i>	A157N	1" Timken Taper Roller Bearing	<i>36</i>	S920019	Lateral Pivot
<i>15</i>	A182	Dust Cap - Small	<i>37</i>	S732005	Washer
<i>16</i>	A119	3/8 X 3/4 UNF Setscrew	<i>38</i>	S573174	Washer M25 X 50
<i>17</i>	A160D	Dished Disc	<i>39</i>	S590407	Spirol Pin M8 X 35
<i>20</i>	S571366	Nut M16 X 7	<i>40</i>	S719001	Grease Nipple M8
	S571216	Nut M16 X 15	<i>41</i>	S910395B	Marker Mounting Bracket Left
<i>21</i>	S571216	Nut M16 X 15	<i>41B</i>	S910395	Marker Mounting Bracket Right
<i>22</i>	S573166	Washer M16	<i>42</i>	S552731	Mounting Bracket Bolt M16 x 50
<i>23</i>	S573170	Washer M20		S573166	Mounting Bracket Washer M16
<i>24</i>	S573905	Nylon Bush Locator		S571416	Mounting Bracket Nut M16
<i>25</i>	S981801	Nylon Bush	<i>43</i>	S683013	Hydraulic Hose Tractor/ Shuttle Valve
<i>26</i>	S964064	Nylon Ram Locator	<i>44</i>	S683009	Shuttle Valve
<i>27</i>	S981302	Spring	<i>45</i>	S683009	Hydraulic Hose Shuttle Valve/Markers
<i>28</i>	S985009	Spring Locator	<i>46</i>	S982301	Marker Ram
<i>29</i>	S592202	R Clip	<i>47</i>	A254	M16 X 40 Setscrew
<i>30</i>	S962074	Marker Stay - Left	<i>48</i>	SM-8AM	Complete Disc Hub Assembly
	S962072	Marker Stay - Right			

Parts list

Electric Parts - Sensors



Parts list

Electric Parts - Sensors

Item	Part No	Description
<i>1</i>	S983917	Low level hopper sensor
<i>2</i>	S983912DS	Distribution shaft sensor
<i>3</i>	S983912AS	Agitator Shaft. Speed/area sensor
<i>4</i>	S983912M	Marker sensor

Parts list

Electric Parts - Chassis

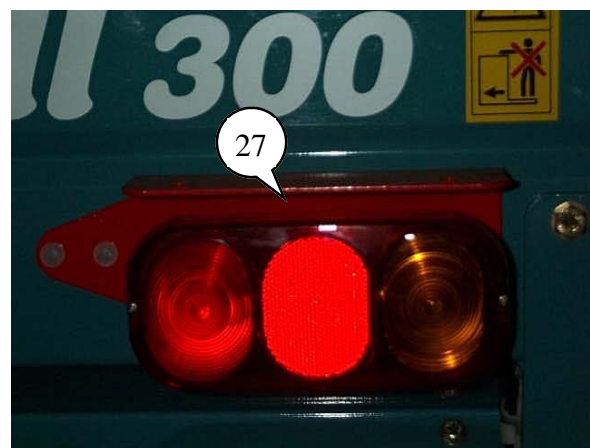
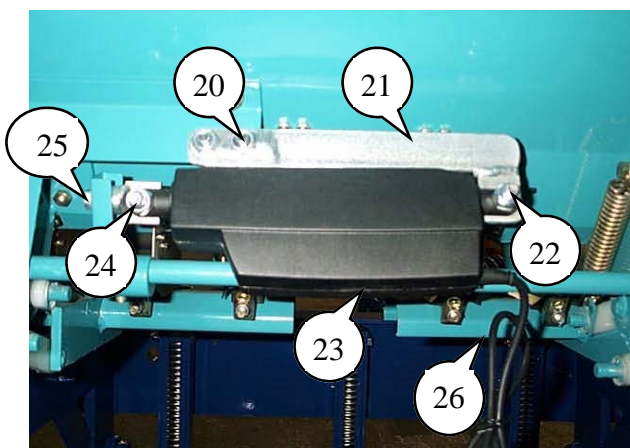
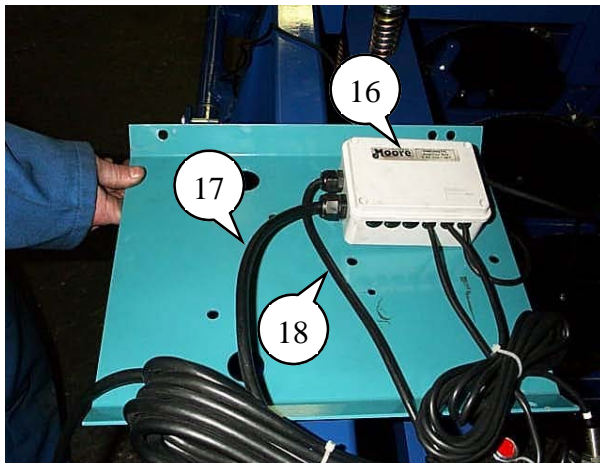
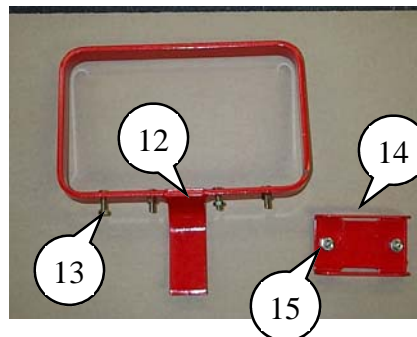
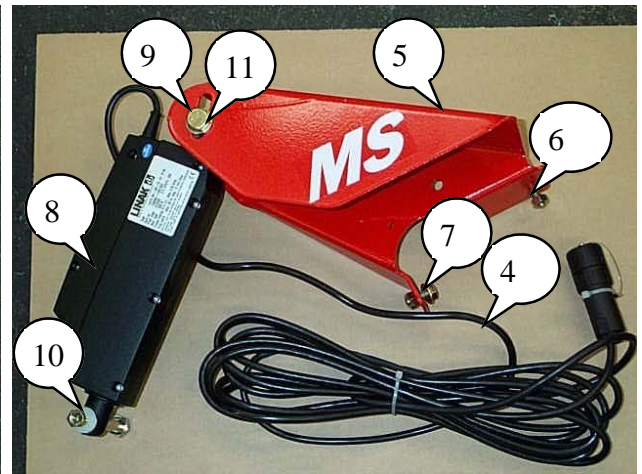
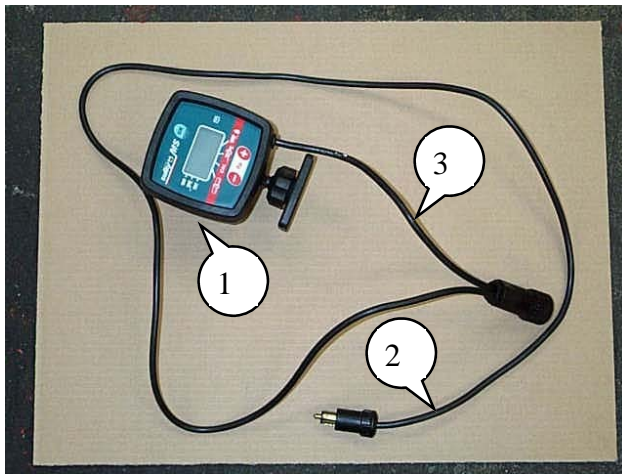

Parts list

Electric Parts - Chassis

Item Number	Part Number	Description
<i>1</i>	MS - 01	MS control pod
<i>2</i>	MS - 02	MS control pod power lead
<i>3</i>	MS - 03	Lead from MS pod to sensor
<i>4</i>	MS - 04	Lead from linak actuator to sensor
<i>5</i>	MS - 05	Linak actuator mounting bracket
<i>6</i>	MS - 06	Mounting bracket setscrews. M8 x 20
<i>7</i>	MS - 07	M8 Washer
<i>8</i>	MS - 08	Linak actuator
<i>9</i>	MS - 09	Linak actuator top bolt. M10 x 100
<i>10</i>	MS - 10	Linak actuator bottom bolt. M10 x 100
<i>11</i>	MS - 11	M10 Washer
<i>12</i>	MS - 12	MS pod mounting bracket
<i>13</i>	MS - 13	Ms pod mounting bracket setscrews. M6 x 20
<i>14</i>	MS - 14	Mounting bracket clamp
<i>15</i>	MS - 15	Mounting bracket clamp setscrews. M8 x 35
<i>16</i>	MT - 01	Moore Tronic Junction box
<i>17</i>	MT - 02	Junction box / Control Pod signal cable
<i>18</i>	MT - 03	Tractor power lead
<i>19</i>	MT - 04	Moore Tronic control pod
<i>20</i>	A219	M8 x 20 Bolt
	A140	M8 Nyloc nut
<i>21</i>	LA - 03	Linak Actuator mounting bracket
<i>22</i>	A218	M8 x 35 Bolt
	A140	M8 Nyloc nut
<i>23</i>	A201	Linak Actuator
<i>24</i>	A218	M8 x 35 Bolt
	A140	M8 Nyloc nut
<i>25</i>	S555660	M6 x 10 Setscrew
<i>26</i>	A140C	Linak Actuator power cable
<i>27</i>	A233	Road lights and cable.

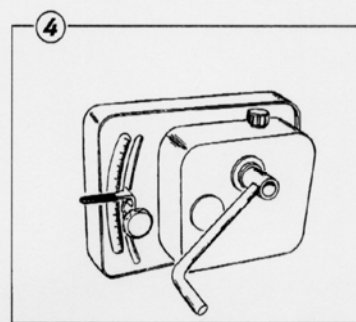
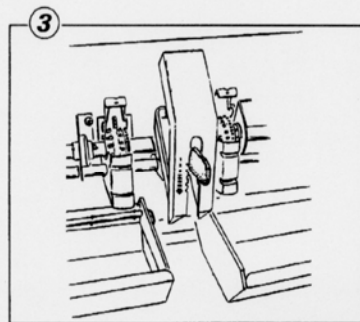
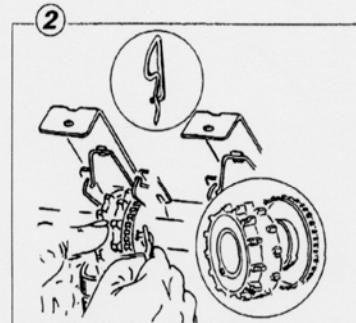
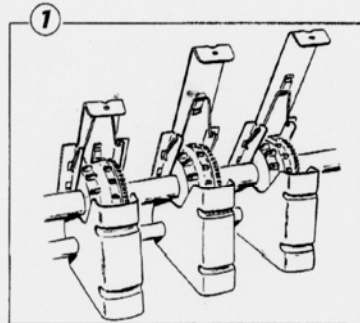

The calibration charts are only stated for information purposes only. Check your spreading rate per hectare for greater precision.

CALIBRATION CHARTS

A) Available Preset Reminders



1. Shutters (3 positions)
2. Peg Wheels (2 positions)
3. Base Flap (6 positions)
4. Variator (Markers 0 to 90)

B) Calibration Charts

- | | |
|--|----|
| * Wheat | 82 |
| * Rape, Barley, Peas and Beans | 83 |
| * Oat, Mustard, Phacelia and Radish | 84 |
| * Lucern, Linseed, Rye-grass and Clover. | 85 |

Calibration Charts

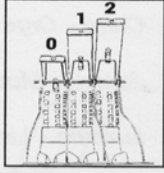
Table 1. Recommended Shutter, Base flap and Peg wheel Positions.

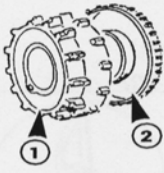
	Shutter Opening	Base Flap Position	Peg wheel selection
			
Colza Rape Raps	1	1	2
Luzerne Lucern Luzerne	1	1	1
Ray grass Rye grass Ray gras	1	1	1
Blé Wheat Weizen	2	1	1
Orge Barley Gerste	2	1	1
Pois Peas Erbesen	2	5	1
Phacélie Phacelia Phazelia	1	1	1
Avoine Oat Hafer	2	1	1
Lin Linseed Leinsaat	1	1	1
Radis Radish Radieschen	1	1	1
Moutarde Mustard Senfsamen	1	1	2
Féverole Field beans Ackerbohnen	2	6	1
Trèfle Clover Klee	1	1	1



Calibration Charts

An example detailing how to use the calibration chart.

Setting Chart for Wheat.

Note: Row spacing is 16 for both 3/4 metre Unidrill

Working width. No of rows. Row spacing

		
2,50	17	16
	21	12
3	18	17
	19	16
	21	14
3,50	23	15
	29	12
4	24	17
	27	15
	29	14
	33	12
4,5	29	15,5
	33	14
4,8	33	14,5
5	33	15
6	40	
	44	
	48	
6,66	44	
	48	

Seed Rate

Blé / Wheat / Weizen							
	12	13	14	15	16	17	
kg/ha							
71		20	22	24	26	28	30
80	160	23	25	28	30	32	34
90	180	27	29	32	34	35	39
100	200	30	33	35	38	40	43
110	220	33	36	39	42	44	47
120	240	36	39	42	45	48	51
130	260	39	43	46	49	52	54
140	280	42	46	49	52	55	58
150	300	45	49	52	55	58	61
160	320	48	52	55	58	62	64
170	340	51	54	58	61	64	67
180	360	53	57	61	64	67	70
190	380	56	60	63	67	70	73
200	400	58	62	66	69	72	75
210	420	61	65	68	72	75	78
220		63	67	71	74	77	80
230		67	71	75	78	81	83
240		69	73	77	80	83	85
250		71	75	79	82	84	86

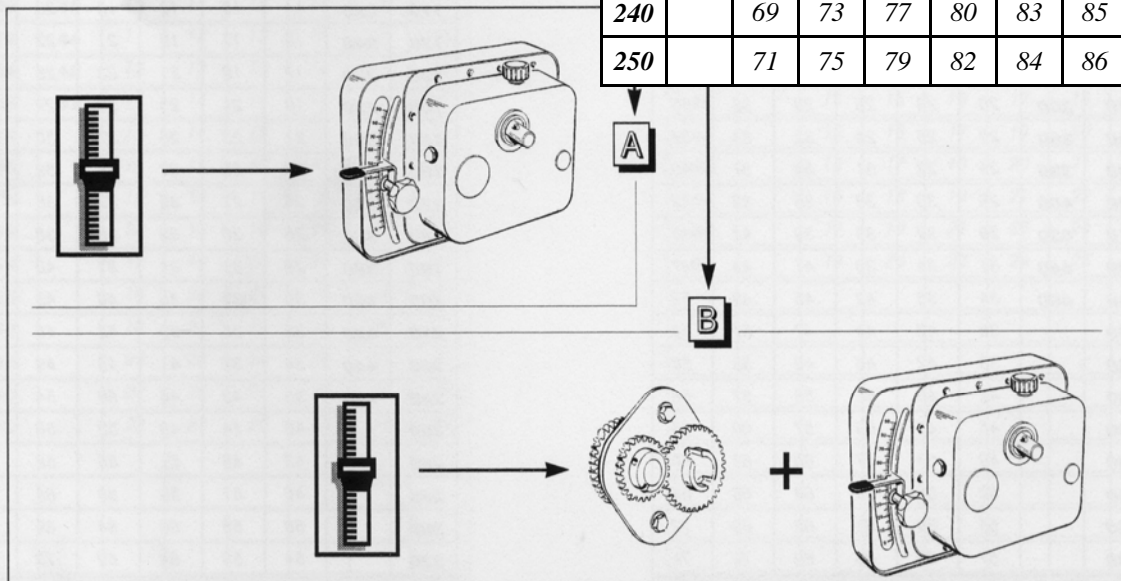

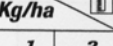

Calibration Charts

Calibration charts for Rape, Barley, Peas and Field Beans.

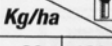
Colza / Rape / Raps							
		12	13	14	15	16	17
							
1	2	4	4	5	5	5	5
1,5	3	6	6	7	7	7	8
2	4	7	8	9	9	10	11
2,5	5	9	10	11	12	12	13
3	6	11	12	13	14	15	16
3,5	7	13	14	15	16	18	19
4	8	15	16	18	19	20	22
4,5	9	17	18	20	22	23	25
5	10	19	21	22	24	26	27
5,5	11	21	23	25	27	29	30
6	12	23	25	27	29	31	33
7	14	27	30	32	34	37	39
8	16	31	34	37	39	42	44
9	18	35	38	41	44	47	50
10	20	39	43	46	49	52	54
11		43	47	50	53	56	58
12		47	50	54	57	59	62
13		50	54	57	60	62	64
14		54	57	60	63	65	66
15		57	60	63	65	66	
A	B						

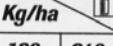
Orge / Barley / Gerste							
		12	13	14	15	16	17
							
90	180	33	36	38	41	44	47
95	190	35	38	41	44	47	49
100	200	36	40	43	46	49	52
105	210	38	42	45	48	51	54
110	220	40	44	47	50	54	57
120	240	44	48	51	55	58	61
130	260	48	52	55	59	62	65
140	280	51	55	59	63	66	69
150	300	55	59	63	66	70	73
160	320	58	62	66	70	73	76
170	340	61	65	69	73	76	80
180	360	64	68	72	76	79	83
190	380	67	71	75	79	82	86
200		70	74	78	82	85	89
210		72	77	81	85	88	
220		75	79	83	87		
240		79	84	88			
250		82	86				
160		84	89				
280		88					
A	B						

Pois / Peas / Erbsen							
		12	13	14	15	16	17
							
120	240		11	13	16	18	20
130	260	11	13	16	18	21	23
140	280	13	15	19	21	24	26
150	300	16	18	21	24	26	29
160	320	18	21	24	26	29	32
170	340	20	23	26	29	32	35
180	360	22	25	28	32	34	37
190	380	24	28	31	34	37	40
200	400	26	30	33	36	39	42
210	420	28	32	35	39	42	45
220	440	31	34	38	41	44	47
240	480	34	38	42	45	49	52
250		36	40	44	47	51	54
260		38	42	46	49	53	56
280		42	46	50	53	57	60
300		45	49	53	57	60	63
320		49	53	57	60	63	66
340		52	56	60	63	66	69
360		55	59	63	66	69	72
380		57	62	65	69	72	74
A	B						

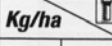
Féverole / Field beans / Ackerbohnen							
		12	13	14	15	16	17
							
100	200	12	14	15	16	18	19
105	210	13	14	16	17	19	20
110	220	14	15	17	18	20	22
120	240	15	17	19	21	22	24
130	260	17	19	21	23	25	27
140	280	19	21	23	25	27	30
150	300	21	23	25	27	30	32
160	320	22	25	27	30	32	35
170	340	24	27	30	32	35	38
180	360	26	29	32	35	38	41
190	380	28	31	34	37	40	44
200	400	30	33	36	40	43	47
210	420	32	35	39	42	46	49
220	440	34	37	41	45	49	52
240	480	38	42	46	50	54	58
250		40	44	48	52	56	60
260		42	46	51	55	59	63
280		46	51	55	60	64	68
300		50	55	60	64	69	73
320		54	59	64	69	73	77
A	B						

Calibration Charts

Calibration charts for Oats, Mustard, Phacelia and Radish

Avoine / Oat / Hafer							
		12	13	14	15	16	17
80		40	42	45	48	51	54
85		42	45	48	51	54	57
90	180	44	47	51	54	57	60
95	190	46	50	53	57	60	63
100	200	48	52	56	59	63	66
105	210	51	54	58	62	65	69
110	220	53	57	61	64	68	71
120	240	57	61	65	69	72	76
130	260	61	66	70	73	77	81
140	280	65	70	74	78	82	86
150	300	69	73	78	82	86	90
160	320	72	77	82	86	91	93
170	340	76	81	86	90	93	94
180	360	79	85	90	93	94	88
190	380	83	88	93	94	89	74
200		86	91	94	91	78	47
210		90	94	93	82	55	

Moutarde / Mustard / Senfsamen							
		12	13	14	15	16	17
2	4	8	9	9	10	10	11
2,5	5	9	10	11	11	12	13
3	6	11	12	12	13	14	15
3,5	7	12	13	14	15	16	17
4	8	13	14	15	17	18	19
4,5	9	15	16	17	18	20	21
5	10	16	18	19	20	22	23
6	12	18	19	21	22	24	26
7	14	21	23	24	26	28	30
8	16	24	26	28	30	32	34
9	18	27	29	32	34	36	38
10	20	30	32	35	37	39	42
11		33	35	38	41	43	46
12		36	38	41	44	47	51
13		38	41	45	48	52	55

Phacélie / Phacelia / Phazelia							
		12	13	14	15	16	17
16	32	8	9	10	10	11	11
18	36	9	10	11	11	12	12
20	40	10	11	12	12	13	14
22	44	11	12	13	13	14	15
24	48	12	13	13	14	15	16
26	52	13	14	14	15	16	17
28		13	14	15	16	17	18
30		14	15	16	17	18	19
32		15	16	17	18	19	21
34		16	17	18	19	21	22
38		17	19	20	21	23	24
40		18	20	21	23	24	25
42		19	21	22	24	25	27
45		20	22	24	25	27	29
48		22	23	25	27	29	30
50		23	24	26	28	30	32

Radis / Radish / Radieschen							
		12	13	14	15	16	17
30	60	9	10	11	11	12	13
34	68	10	11	12	13	14	15
36	72	11	12	13	14	15	16
38		12	13	14	15	16	17
42		13	14	15	16	18	19
45		14	15	16	17	19	20
48		15	16	17	19	20	21
50		15	17	18	20	21	22
53		16	18	19	21	22	24
56		17	19	21	22	24	25
60		19	20	22	24	26	27

Notes

Warranty

In this warranty Moore Uni-Drill is referred to as the Company.

1. Subject to the provisions of this warranty the Company Warrants each new machine sold by it to be sold free from any defect in material or workmanship.
2. If the machine or part there of supplied by the Company is not in accordance with the warranty given in clause 1 the Company will at its option;-
 - (a) Make good the machine at the Company's expense, or
 - (b) make an allowance to the purchaser against the purchase price, or replace the machine as soon as reasonably practicable.
3. This warranty shall not oblige the Company to make any repayment in respect of loss of profit or other consequential loss or contingent liability of the purchaser alleged to arise from any defect in the machine or impose any liability on the company other than that contained in clause 2.
4. Any claim under this warranty must be notified to the company in writing specifying the matters complained of within 12 months from the date of receipt by the purchaser or his/her nominee of the machine.
5. Any claim under this warranty must be made by the original purchaser of the machine and is not assignable to any third party.
6. If the purchaser hires out the machine to any third party the warranty shall apply only to matters notified to the Company within 90 days of the date of delivery and clause 4 shall be read as if the period of 90 days were substituted for the period of 12 months.
7. **The warranty will cease to apply if:-**
 - (a) **any parts not made, supplied or approved in writing by the Company are fitted to the machine, or**
 - (b) **any repair is carried out to the machine other than by or with the express written approval of the Company, or**
 - (c) **any alterations not expressly authorised by the Company in writing are made to the machine, or**
 - (d) **the machine is damaged by accident, or**
 - (e) **the machine is abused or overloaded or used for a purpose or load beyond its design capabilities.**
8. Any dispute as to whether the goods are sold free from any defect in workmanship or materials shall be referred to a single arbitrator to be agreed between the company and the buyer.



In accordance with the program of continuous Development at **MOORE UNIDRILL Ltd**, alterations in the specification may be made at any time without notice.

Therefore **MOORE UNIDRILL Ltd** will not accept responsibility for any discrepancies which may occur between the specification of machines thereof contained in this publication.

MOORE UNIDRILL LTD
33 KIRK ROAD, BALLYMONEY
Co. ANTRIM N.IRELAND BT53 6PP

TEL: (++44) 028276 64444
FAX: (++44) 028276 65696
Email: info@moore-unidrill.com
Website: www.moore-unidrill.com